

Valve-Regulated Lead-Acid (VRLA): Gelled Electrolyte (gel) and Absorbed Glass Mat (AGM) Batteries

EAST PENN Expertise and American Workmanship

Quality System Certified to ISO 9001

Introduction

Valve-regulated lead-acid (VRLA) technology encompasses both gelled electrolyte and absorbed glass mat (AGM) batteries. Both types are valve-regulated and have significant advantages over flooded lead-acid products.

More than a decade ago, East Penn began building valve-regulated batteries using tried and true technology backed by more than 50 years experience. East Penn's unique computer-aided manufacturing expertise and vertical integration have created a product that is recognized as the **highest quality, longest lived VRLA battery available from any source.**

East Penn's gel and AGM batteries are manufactured to tough quality standards. East Penn manufactures high power gel and AGM batteries with excellent performance and life.

Applications

VRLA batteries can be substituted in virtually any flooded lead-acid battery application (in conjunction with well-regulated charging), as well as applications where traditional flooded batteries cannot be used. Because of their unique features and benefits, VRLA batteries are particularly well suited for:

Deep Cycle, Deep Discharge Applications

- Marine Trolling
- Electric Vehicles
- Portable Power
- Personnel Carriers
- Commercial Deep Cycle Applications
- Electronics
- Wheelchairs
- Floor Scrubbers
- Marine & RV House Power
- Sailboats
- Golf Cars

Standby and Emergency Backup Applications

- UPS (Uninterrupted Power Systems)
- Emergency Lighting
- Telephone Switching
- Cable TV
- Computer Backup
- Village Power
- Solar Power

Unusual and Demanding Applications

- Race Cars
- Off-road Vehicles
- Marine & RV Starting
- Air-transported Equipment
- Wet Environments
- Diesel & I.C.E. Starting

What is a gel battery?

A gel battery is a lead-acid electric storage battery that:

- is sealed using special pressure valves and should never be opened.
- is completely maintenance-free.*
- uses thixotropic gelled electrolyte.
- uses a recombination reaction to prevent the escape of hydrogen and oxygen gases normally lost in a flooded lead-acid battery (particularly in deep cycle applications).

- is non-spillable, and therefore can be operated in virtually any position. However, upside-down installation is not recommended.
- * Connections must be retorqued and the batteries should be cleaned periodically.

What is an AGM battery?

An AGM battery is a lead-acid electric storage battery that:

- is sealed using special pressure valves and should never be opened.
- is completely maintenance-free.*
- has all of its electrolyte absorbed in separators consisting of a sponge-like mass of matted glass fibers.
- uses a recombination reaction to prevent the escape of hydrogen and oxygen gases normally lost in a flooded lead-acid battery (particularly in deep cycle applications).
- is non-spillable, and therefore can be operated in virtually any position. However, upside-down installation is not recommended.

* Connections must be retorqued and the batteries should be cleaned periodically.

How does a VRLA battery work?

A VRLA battery is a "recombinant" battery. This means that the oxygen normally produced on the positive plates of all lead-acid batteries is absorbed by the negative plate. This suppresses the production of hydrogen at the negative plate. Water (H₂O) is produced instead, retaining the moisture within the battery.

It never needs watering, and should never be opened as this would "poison" the battery with additional oxygen from the air. Opening the battery will void the warranty.

What are the differences between gel batteries and absorbed glass mat (AGM) batteries?

Both are recombinant batteries. Both are sealed valve-regulated (SVR) – also called valve-regulated lead-acid (VRLA). AGM batteries and gel batteries are both considered "acid-starved". In a gel battery, the electrolyte does not flow like a normal liquid. The electrolyte has the consistency and appearance of petroleum jelly. Like gelled electrolyte batteries, absorbed electrolyte batteries are also considered non-spillable – all of the liquid electrolyte is trapped in the sponge-like matted glass fiber separator material.

The "acid-starved" condition of gel and AGM batteries protects the plates during heavy deep-discharges. The gel battery is more starved, giving more protection to the plate; therefore, it is better suited for super-deep discharge applications.

Due to the physical properties of the gelled electrolyte, gel battery power declines faster than an AGM battery's as the temperature drops below 32°F. AGM batteries excel for high current, high power applications and in extremely cold environments.

What is the difference between VRLA batteries and traditional wet batteries?

Wet batteries do not have special pressurized sealing vents, as they do not work on the recombination principle. They contain liquid electrolyte that can spill and cause corrosion if tipped or punctured. Therefore, they are not air transportable without special containers. They cannot be shipped via UPS or Parcel Post or used near sensitive electronic equipment. They can only be installed "upright."

Wet batteries lose capacity and become permanently damaged if:

- left in a discharged condition for any length of time (due to sulfation). This is especially true of antimony and hybrid types.
- continually over-discharged, due to active material shedding. This is especially true of automotive starting types.

Our gel cells have triple the deep cycle life of wet cell antimony alloy deep cycle batteries, due to our unique design. The shelf life of a VRLA battery is seven times higher than the shelf life of a deep cycle antimony battery.

How do VRLA batteries recharge? Are there any special precautions?

While our VRLA batteries accept a charge extremely well due to their low internal resistance, **any** battery will be damaged by continual under- or overcharging. Capacity is reduced and life is shortened.

Overcharging is especially harmful to any VRLA battery because of the sealed design. Overcharging dries out the electrolyte by driving the oxygen and hydrogen out of the battery through the pressure relief valves. Performance and life are reduced.

If a battery is continually undercharged, a power-robbing layer of sulfate will build up on the positive plate, which acts as a barrier to recharging. Premature plate shedding can also occur. Performance is reduced and life is shortened.

Therefore, **it is critical that a charger be used that limits voltage.** The charger must be temperature-compensated to prevent under- or overcharging due to ambient temperature changes. (See **Charging Voltage vs. Ambient Temperature chart on page 11.**)

Important Charging Instructions

The warranty is void if improperly charged. Use a good constant potential, temperature-compensated, voltage-regulated charger. **Constant current chargers should never be used on VRLA batteries.**

Can VRLA batteries be installed in sealed battery boxes?

NO! Never install any type of battery in a completely sealed container. Although most of the normal gasses (oxygen and hydrogen) produced in a VRLA battery will be recombined as described above, and not escape, **oxygen and hydrogen will escape from the battery in an overcharge condition** (as is typical of any type battery).

For safety's sake, these potentially explosive gasses **must** be allowed to vent to the atmosphere and **must never be trapped in a sealed battery box or tightly enclosed space!**

Can our VRLA batteries be used as starting batteries as well?

Our VRLA batteries will work in SLI (Starting, Lighting and Ignition) applications as long as the charging voltage is regulated to the appropriate values from the tables on page 11. Many vehicle regulators are set too high for gel batteries; therefore, the charging system may require adjustment to properly recharge a gel battery for best performance and life.

AGM batteries excel in low temperature, high current applications such as cold weather starting.

What do the ratings and specifications signify for this line?

All ratings are **after 15 cycles** and conform to BCI specifications.

CCA = Cold Cranking Amperes at 0°F (-17.8°C)

Cold cranking amperes equal the number of amperes a new, fully charged battery will deliver at 0°F (-17.8°C) for thirty seconds of discharge and maintain at least 1.2 volts per cell (7.2 volts for a 12-volt battery).

CA = Cranking Amperes at 32°F (0°C)

Same as above, tested at 32°F (0°C).

RC = Reserve Capacity at 80°F (27°C)

The reserve capacity is the time in minutes that a new, fully charged battery can be continuously discharged at 25 amperes and maintain at least 1.75 volts per cell (10.5 volts for a 12-volt battery).

Minutes discharged at 50, 25, 15, 8 and 5 Amperes

Minutes discharged is the time in minutes that a new, fully charged battery will deliver at various currents and maintain at least 1.75 volts per cell. These are nominal or average ratings.

Ampere Hour Capacity at 20, 6, 3 and 1 Hour Rates

Ampere hour capacity is a unit of measure that is calculated by multiplying the current in amperes by the time in hours of discharge to 1.75 volts per cell. These are nominal or average ratings.

EXAMPLE

10 amperes for 20 hours (10 x 20) = 200 Ah @ the 20-hour rate
8 amperes for 3 hours (8 x 3) = 24 Ah @ the 3-hour rate
30 amperes for 1 hour (30 x 1) = 30 Ah @ the 1-hour rate

Therefore, if you have an application that requires a draw of 17 amperes for 3 hours, you would need a 51 Ah battery (@ the 3 hour rate)...(17 x 3 = 51). However, this is 100% of the capacity of this 51 Ah battery.

Most system designs will specify a battery that will deliver a minimum of twice the capacity required. This means the battery will discharge to 50% of its capacity. Using a 50% depth of discharge (versus 80% or 100%) will dramatically extend the life of any battery. Therefore, when helping to specify a battery for a system, choose a battery with at least **twice** the capacity required for best performance. If 50 Ah is required, specify at least a 100 Ah battery.

CHART A

Independent Laboratory Testing BCI 2-Hour Life

Group Size "27" Batteries East Penn Gel and AGM vs. Competitor

This chart compares the cycles run until the battery capacity dropped to 50% of the 15th cycle's capacity (on discharges at the 2-hour rate to a 10.5-volt cutoff).

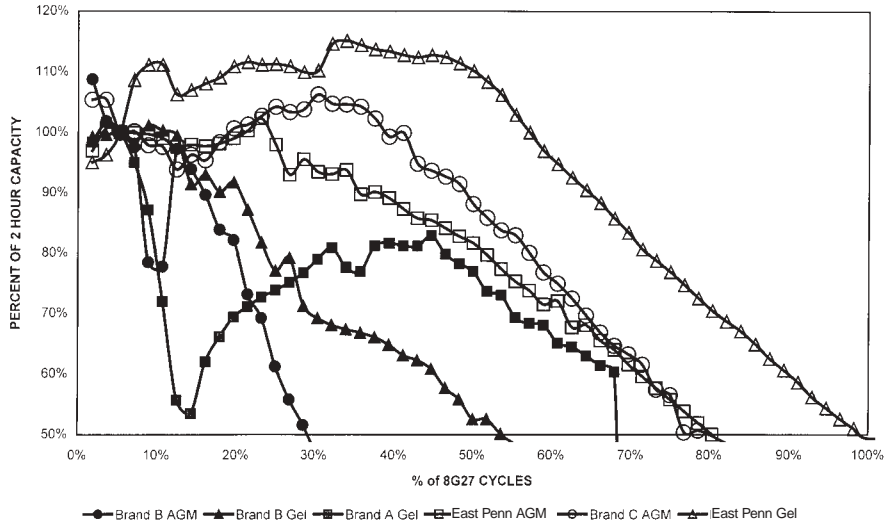

CHART B

Charging Current vs. Charging Time

Shown is the current needed to charge a battery from 0% to 90% state of charge in a given time. Or time required to charge a battery from 0% to 90% state of charge at a given current. For example, to charge an 8G8D (curve H) to 90% in 3.5 hours, 100 amperes are required; at 35 amperes, it would take 10 hours

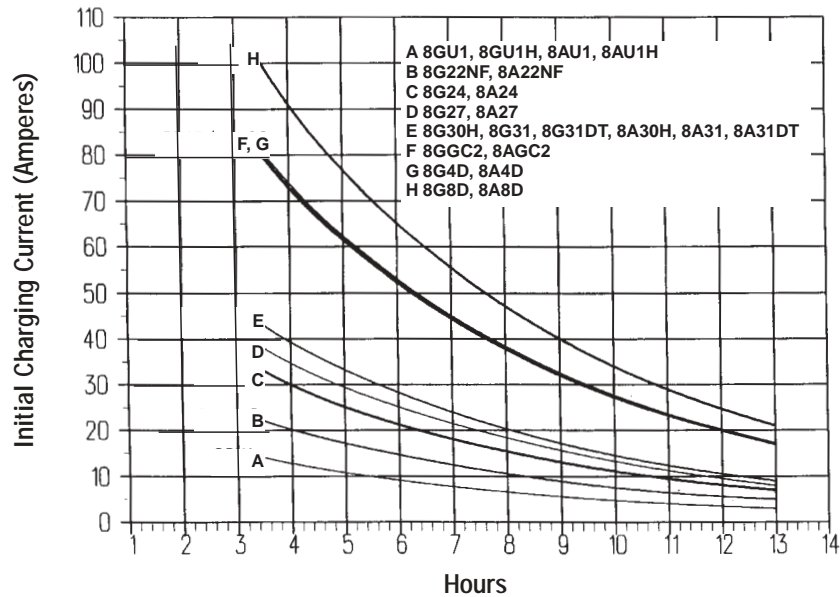

CHART C
VRLA Battery Voltage During Constant Current Discharge
Voltage vs. Percent Discharged

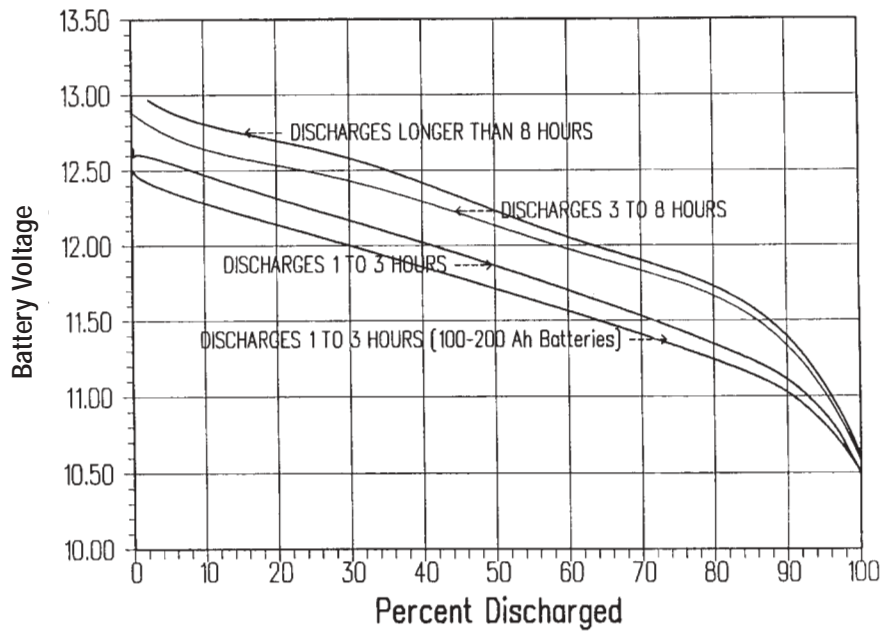
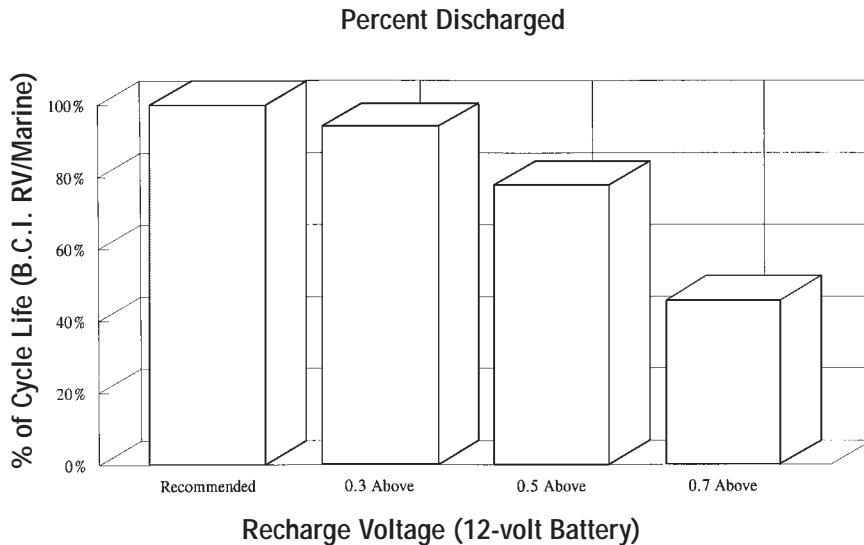

CHART D
Gel Percent Cycle Life vs. Recharge Voltage

This chart shows the effect on life of overcharging a gel battery.
 (e.g.: Consistently charging at 0.7 volts above the recommended level reduces life by almost 60%!)



What are the features and benefits that make East Penn's VRLA batteries unique?

East Penn Expertise

East Penn builds VRLA batteries to the highest standards. Our manufacturing process features improved controls using state-of-the-art computers and the latest manufacturing technology and equipment. Therefore, the VRLA batteries produced by East Penn consistently meet the highest quality performance and life standards.

Ultrapremium Sealing Valve

A critical feature of any VRLA battery, gelled or absorbed, is the quality of the sealing valve. Not only must the valve keep the cell pressurized and safely release excessive pressure and gas due to overcharging, but it must also keep the cell from being contaminated by the atmosphere. Oxygen contamination will discharge a VRLA battery and eventually ruin the battery.

Our valves are UL recognized and 100% tested after manufacturing. The benefit is **reliable performance and long life**.

Spillproof and Leakproof

A major advantage of VRLA batteries is their spillproof and leakproof feature. However, all VRLA batteries are not created equal in their degree of non-spillability. Some manufacturer's AGM batteries are unevenly filled. Over-saturation of the separators leaves liquid electrolyte that could spill. Under-saturation could lead to premature failure. Some gels do not set properly; they remain liquid and can leak or spill.

Our exclusive gel electrolyte is formulated, mixed and controlled to assure proper "set" in every battery. East Penn's computer-controlled gel mixing and filling equipment ensures homogenization of the mix. This assures a gel battery that will not spill or leak. This feature allows our gel cell to be operated in virtually any position. However, we do not recommend an upside-down orientation.

The AGM filling process assures that each cell is saturated with the maximum amount of electrolyte that can be held by the separators, without leaving excess electrolyte that could spill or leak.

Exclusive Gel Formula

The gelled electrolyte is another critical element in this type of battery. Our gelled electrolyte contains sulfuric acid, fumed silica, pure demineralized, deionized water, and a phosphoric acid additive. The phosphoric acid is a key reason that our batteries deliver **dramatically longer cycle life** than leading gel competitors and 3 times longer cycle life than traditional wet cells.

Exclusive AGM Electrolyte

Our AGM electrolyte contains high purity sulfuric acid and absolutely pure totally demineralized, deionized water to increase battery performance. Since the designs are "acid-starved" to protect the plates from deep discharge, the acid concentration can drop to nearly zero during an extremely deep discharge. Substances that will not dissolve in acid may become soluble when the concentration drops this low. Upon recharge, these dissolved substances crystallize out of the electrolyte, potentially destroying the battery. Our electrolyte prevents these events.

Exclusive Computerized Gel Mixing

Proper gel mixing is critical to life and performance. Consistency in mixing means consistent reliability. We have designed and built the newest, state-of-the-art gel battery manufacturing facility in the world. An example is our proprietary computerized gel mixing operation.

Our exclusive formula is mixed using computer control in every stage of the process. **Computer control delivers superior consistency for gel battery performance that is unequalled.**

Our temperature-controlled process and specially designed equipment assure a homogenous gel. It is important to note that our equipment was designed by our engineers specifically for gel mixing... even down to the contour of the tank bottoms and feed pipe locations. **No other battery manufacturer has comparable equipment.**

Multi-Staged Filling/Vacuuming Operation

Most other manufacturers fill their gel cells in a one step process, vibrating the battery with hopes of releasing most of the air pockets. This system is less than perfect and leaves voids or air pockets at the critical gel-to-plate interface. These voids are non-reactive and reduce overall battery performance.

Our process fills and vacuums each cell several times. This multi-step process assures complete evacuation of air and **complete gel-to-plate interface**. Our computerized process also weighs every battery before and after filling as a check for proper gel levels. The benefit is **more power-per-pound of battery**.

Our AGM topping process assures that the maximum retainable electrolyte quantity is held within the battery separators, without leaving any unabsorbed liquid to spill or leak.

Tank Formed Plates

East Penn is the **only** battery manufacturer that uses tank formation to activate the battery plates. This process **guarantees a fully formed and voltage matched plate**. The extra handling of the plates provides an additional inspection step in the process to verify plate quality.

Ultrapremium, Gel Glass Mat, Double Insulating Separators

Another critical component is the separator, which isolates the positive from the negative plate. The separator must allow maximum charge flow between the plates for maximum performance. Separator failure is a leading cause of warranty claims and customer dissatisfaction.

East Penn uses an **ultrapremium grade separator** in our gel batteries. We believe that this expense (which is 5 to 6 times higher than other types) is worth the benefits of extended life and performance:

- The fiberglass mats embed themselves into the surface of the plates, acting like reinforcing rods in concrete. This extra reinforcement locks the active material onto the plate for longer life and extended performance.
- The ultra-clean separators have no oil contamination or other impurities. Therefore, **resistance is low and battery performance is high**.
- Excellent porosity allows maximum charge flow, which means **more power-per-pound**.
- Superior resistance to oxidation dramatically reduces separator failure, which **extends life**.
- Our separators are **especially suited for gel batteries**, while others use separators designed for flooded automotive batteries.

Ultrapremium AGM glass mat separators

Glass mat separator properties can vary considerably. East Penn uses glass mat engineered to have an ideal balance of properties—i.e. absorbency, compressibility, puncture resistance and electrical resistance. This attention to detail results in high performance and long life.

Exclusive Thru-Partition Weld Seals

One of the causes of self-discharge in batteries is the minute electrical currents that flow between each cell through the partition at the weld area. These currents accelerate the discharge of batteries not in use.

We block these currents by using an **exclusive weld seal** or gasket. This feature **dramatically reduces self-discharge** to less than 3% per month: the lowest self-discharge rate of any battery manufacturer and seven times lower than many conventional batteries!

Exclusive Patented Calcium/Copper Lead Alloy Grids

This exclusive alloy provides **longer shelf life, more power-per-pound and superior corrosion resistance**. By using special grain refiners, we can **dramatically improve performance and life**.

Heavy-Duty Motive Power Style Grid Design

While other manufacturers cut costs by using automotive style grids, we use a high-performance deep cycle grid. This heavy-duty grid design is similar to the grid in a motive power battery.

The hefty “power rods” designed into our grids not only lock the active material onto the grid, but also act as “bus bars” to collect and direct the energy to the terminals. The benefit is **more power-per-pound** of battery for your equipment and **longer battery life**.

Multiple Plate Lug Milling

Shiny, well milled plate lugs are critical to our superior cast-on-strap quality. Each of our plate lugs is automatically milled **to assure the highest quality** strap with no loose or dropped plates. Our lugs are then fluxed and tinned automatically for an **additional assurance of quality**.

Heavier Plate Straps

We use an **exclusive lead/tin alloy** in a unique multi-stage cast-on-strap operation. The result is heavier straps with **outstanding lug-to-strap knit**. This eliminates dropped and loose plates, thereby **improving performance and life**.

Polyester Element Wrap

Another cause of deep-cycle battery failure is “mossing.” This phenomenon occurs late in a battery’s life, as the positive active material actually grows around the edge of the separator and eventually “shorts” against the negative plate. This ends the battery’s service life.

Our AGM separators wrap around the bottom of the plate and are wider than the plates. This makes mossing failures unlikely. To prevent life-shortening mossing in our gel batteries, we use a **special polyester fiber sheet** that is wrapped around the edge of each element, similar to the wrap in an industrial battery. The result is **longer service life**.

Exclusive Forged Posts and Bushings

“Black” posts and oxygen-contaminated batteries are often due to porous lead terminal posts. A battery can lose its critical pressure through tiny pores and fissures in the battery terminals. Pressure

loss is harmful to the battery and is evident by black posts, which are caused by sulfuric acid fumes escaping from the battery through and around the lead posts and bushings. These fumes can cause corrosion and can damage sensitive electronic equipment.

These pores and fissures are caused by the industry’s method of casting posts and bushings. This method produces tiny air pockets and paths which allow corrosive gas to escape, causing life shortening depressurization, cell dry-out and corrosion damage.

To eliminate this problem, **we use forged terminal posts and bushings**, which are completely solid with absolutely **no porosity**. The benefit is **longer life**, better performance and **no leakage of corrosive gas**...especially important when installed in or near sensitive electronic equipment.

Acid Stratification Prevention

Acid stratification can occur in conventional wet cells. During charge, acid is released at the plate surfaces. During discharge, acid is consumed at the plate surfaces. Since the concentration is not uniform, diffusion (spontaneous mixing by random molecular motions) begins. If this mixing occurred rapidly, stratification would not occur, but it is relatively slow, allowing lighter parts of electrolyte to “float” toward the surface and heavier parts to “sink” toward the bottom.

The top portion of the plates do not perform as well in contact with lower concentration electrolyte. The bottom portion of the plates do not perform as well with the higher concentration, and will corrode prematurely. High voltage “equalization” charging is sometimes used in wet batteries to make gas bubbles that re-mix the electrolyte.

Because the immobilized gel will not “float” or “sink” within itself when a non-uniform concentration exists, it cannot stratify. Therefore, **no high-voltage equalizing charge is necessary**. Simply recharge at the standard 13.8 to 14.1 voltage setting. This means **longer life and consistent performance** in stationary and standby applications.

Electrolyte in an AGM battery is strongly held by the capillary forces between the glass mat fibers, but not completely immobilized. Stratification is possible in extremely tall cells, but cannot occur in batteries of the size covered in this document.

Convenient Carrying Handles

Carrying handles are included on the (gel) 8GU1H, 8G24, 8G27, 8G30H, 8G31DT, 8G31, 8G4D and 8G8D models. Handles are also available on (AGM) 8AU1H, 8A24, 8A27, 8A31DT, 8A4D and 8A8D. **This feature makes carrying, installation and removal easier, more convenient and less time consuming.**

Dozens of Terminal Options Available

Our batteries are delivered with the most popular type of terminal; however, on a special order basis **many terminal options are available**. This gives you total flexibility to specify the **proper terminal for your application**... without making compromises.

Proprietary Case, Cover, and Pressure Vent

We design and mold our own rugged polypropylene cases, vents and covers in our on-site, state-of the-art plastics molding facility. This provides **ultimate control** of our high performance designs, quality and delivery to our manufacturing plant, **assuring you the highest quality** battery and most reliable service.

Environment and Worker Protection

It's nice to know that every possible safeguard was designed into our process to **protect our co-workers and the environment**... special safeguards that are exclusive to East Penn. One benefit is assurance of a consistent source for batteries without fear of governmental interference or delays.

Over 250 Quality Assurance Checks

Hundreds of quality checks are performed to assure total confidence in the performance and life of our batteries.

For example:

- **100% Cycling.** After initial charging, **every battery is discharged and then recharged** at the factory. This allows us to check the performance of the battery and give it a second charge that **equalizes the cells for improved performance and longer life.**

It's interesting to note that, as a cost-saving measure, we use the current generated during the initial discharge to recharge other batteries in this computer-controlled process.

- **Extended Shelf Stand Test.** Before shipment, every battery is required to stand for a designated period of time. Beginning and ending voltages are compared. This **extra quality assurance step** verifies that the critical pressure control valves are functioning properly.
- **Filling Weight Control.** During this computerized process, batteries are weighed before and after filling. This **assures that the exact amount of electrolyte** is in each battery.
- **Multi-Staged Filling and Vacuuming Process.** Every battery is filled and vacuumed several times during this computerized process. Multi-staged vacuuming **assures complete electrolyte-to-plate interface**, with no power-robbing air pockets.
- **Computerized Polarity Check.** Every battery is checked by computer for proper polarity.
- **High Rate Discharge Test.** Every battery is discharged at approximately twice the rated capacity. A sensitive computer monitors the voltage drop during this discharge to assure that every battery performs as designed.
- **Formed Element Inspection.** Elements are assembled and **charged outside the battery container** in a computerized forming and drying process. This allows visual inspection of every grid, plate, separator, and formed element before being sealed inside the battery, assuring perfect cell elements with longest life and highest performance.
- **Tank Formed Plates.** Voltage matched plates are critical in standby applications. Forming each plate outside the battery assures the **highest quality**, best matched plates in the industry, and also allows a visual check before and during assembly.

State-of-the-Art Technology

Within our newly constructed multi-million dollar VRLA production facility, we have incorporated **state-of-the-art manufacturing processes** that are unmatched by any other battery manufacturer. This major addition allows us to build the **most modern and reliable VRLA batteries in the industry.**

The designs of East Penn's VRLA batteries are always improving. The preceding sections accurately describe East Penn's VRLA products as of the date of publication. East Penn reserves the right to change their processes to improve quality, value or utilize advances in manufacturing technology. Ratings and capacities may change without notice.

How do East Penn's VRLA battery features compare with other types of batteries?

FEATURE		EPM GEL	OTHER GEL	EPM AGM	OTHER AGM	ALL WET CELLS
1.	EPM Expertise	YES	NO	YES	NO	EPM ONLY
2.	Spillproof and Leakproof	YES	YES	YES	YES	NO
3.	Sealed Valve-Regulated	YES	YES	YES	YES	NO
4.	Ultra-Premium Sealing Valve	YES	NO	YES	NO	NO
5.	Exclusive Gel Formula	YES	NO	NO	NO	NO
6.	Deep Discharge Protection	YES	YES	YES	YES	NO
7.	Exclusive Computerized Gel Mixing	YES	NO	NO	NO	NO
8.	Tank Formed Plates	YES	NO	YES	NO	NO
9.	Multi-Staged Gel Filling/Vacuuming	YES	NO	NO	NO	NO
10.	Ultra-Premium Glass-Mat Dual Insulating Separators	YES	NO	NO	NO	NO
11.	Exclusive Thru-Partition Weld Seals	YES	NO	YES	NO	NO
12.	Exclusive Patented Calcium/Copper Lead Alloy Grids	YES	NO	YES	NO	NO
13.	Heavy-Duty Motive Power Style Grids	YES	NO	YES	NO	NO
14.	Grid Lug Milling, Brushing and Fluxing	YES	?	YES	NO	EPM ONLY
15.	Heavy-Duty Special Alloy Plate Straps	YES	NO	YES	NO	NO
16.	Special Polyester "Moss Guard" Element Wrap	YES	NO	NO	NO	NO
17.	Forged Posts and Bushings	YES	NO	YES	NO	EPM ONLY
18.	Acid Stratification Prevention	YES	YES	YES	YES	NO
19.	Carrying Handles	YES	?	YES	LIMITED	LIMITED
20.	Dozens of Terminal Options	YES	?	YES	?	EPM ONLY
21.	Highest Cycle Life	YES	NO	YES	NO	NO
22.	Highest Performance	YES	NO	YES	NO	N.A.
23.	Shelf Stand Test	YES	?	YES	NO	NO
24.	250+ Quality Assurance Checks w/ ISO 9001 Certification	YES	?	YES	NO	EPM ONLY
25.	State-of-the-Art Technology & Facility	YES	NO	YES	NO	EPM ONLY

Answers to the Most Frequently Asked Questions

NOTE: Before reviewing this section, be sure you understand the difference between gel, AGM, and flooded batteries.

How do we justify the premium price of VRLA batteries to those unfamiliar with this type of battery?

Simply review the advantages, features and benefits, performance, and **impressive life cycle results**. Based upon this and the **lowest cost-per-month or duty cycle** you and/or your customer should have no trouble choosing VRLA batteries.

However, please remember that these batteries are not for everyone or every application. Always be aware of the charging considerations. (See pages 11 & 12.)

What are the advantages and disadvantages of the different types of battery designs?

Gelled Electrolyte Advantages:

- Totally maintenance-free
- Air transportable
- Spillproof/leakproof
- No corrosion
- Superior deep cycle life
- Installs upright or on side (side installation may lose about 10% capacity)
- Very low to no gassing (unless overcharged)
- Compatible with sensitive electronic equipment
- Superior shelf life
- Superior rechargeability (from 0% to 90% in 3½ hours)
- No recharge current limitation @ 13.8 volts
- Rugged and vibration-resistant
- Very safe at sea with no chlorine gas in bilge (due to sulfuric acid and salt water mixing)
- Versatile: Starting, Deep Cycle, Stationary
- Operates in wet environments...even under 30 feet of water
- Will not freeze to -20°F/-30°C (if fully charged)
- Lowest cost-per-month (cost ÷ months of life)
- Lowest cost-per-cycle (cost ÷ life cycles)

Gelled Electrolyte Disadvantages:

- Higher initial cost
- Heavier weight
- Water cannot be replaced if continually overcharged
- Automatic temperature-sensing, voltage-regulated chargers **must** be used
- Charge voltage **must** be limited to extend life (13.8 to 14.1 volts maximum at 68°F)

Absorbed Electrolyte Advantages:

- Totally maintenance-free
- Air transportable
- Spillproof/leakproof
- No corrosion
- Installs upright or on side
- Lower cost than gel cell batteries
- Compatible with sensitive electronic equipment
- Very low to no gassing (unless overcharged)
- Excellent for starting and stationary applications
- Superior for shorter duration/higher rate discharges
- Superior under extreme cold conditions when fully charged
- Superior shelf life
- Superior rechargeability (from 0% to 90% in 3½ hours)
- Rugged and vibration-resistant
- Very safe at sea with no chlorine gas in bilge (due to sulfuric acid and salt water mixing)
- Operates in wet environments...even under 30 feet of water

Absorbed Electrolyte Disadvantages:

- Shorter cycle life than gel in very deep cycle applications
- Automatic temperature-sensing, voltage-regulated chargers **must** be used
- Water cannot be replaced if continually overcharged
- Charge voltage **must** be limited (14.4 to 14.6 volts maximum at 68°F)

Flooded Electrolyte Advantages:

- Lowest initial cost
- Higher cranking amps
- Water can be added (if accessible)
- Excellent for starting applications
- Tolerant of improper recharge voltage
- Certain designs are good for deep cycle applications
- Replacements readily available
- Good under extreme cold conditions when fully charged

Flooded Electrolyte Disadvantages:

- Spillable
- Operates upright only
- Shorter shelf life
- Fewer shipping options
- Cannot be installed near sensitive electronic equipment
- Watering may be required (if accessible)

Why can't VRLA batteries be opened?

VRLA (Valve-Regulated Lead-Acid) batteries, sometimes called SLA (Sealed Lead-Acid) batteries or SVR (Sealed Valve-Regulated) batteries work on a recombination principle. Oxygen gas is produced at the positive plates during charge. The charged negative plates react first with this oxygen and subsequently with the electrolyte. Water is produced and the negative plates are very slightly discharged. Additional charging recharges the negative plates instead of producing hydrogen gas. Since very little hydrogen and oxygen is lost and the water (H₂O) is retained, we say that the gasses have recombined. To work properly, the oxygen produced must be retained in the battery until the reaction is completed. Positive pressure allows the gas to be retained.

If any VRLA (gelled or absorbed electrolyte) battery is overcharged, gas will be vented from the valves. Hydrogen as well as oxygen will be released. If continued, the electrolyte will eventually dry out and the battery will fail prematurely. This is why charging limits are so critical.

In a sealed battery a balance is maintained between the hydrogen, oxygen and charge. If a VRLA battery is opened, or leaks, the negative plates are exposed to extra oxygen from the atmosphere. This excess oxygen upsets the balance. The negative plates become discharged. The positive plates may be subsequently severely overcharged. The battery *will* fail prematurely, and the **warranty will be voided**.

Some say calcium grids don't do well in flooded deep cycle applications. Why does East Penn use calcium grids in VRLA batteries for deep cycle applications?

Flooded calcium alloy makes a very efficient, low resistance battery. Therefore, when deeply discharged, the plates release all their available power, eventually causing plate shedding and active material fall-out. In contrast, with flooded antimony batteries, the antimony helps lock the active material onto the grid. Therefore, the plate does not shed as easily, which extends the deep cycle life of the battery when compared to flooded calcium.

Our VRLA calcium alloy battery (**East Penn's exclusive patented alloy**) is also very efficient with low resistance. However, when deeply discharged, the electrolyte is used up before the plates are totally discharged because the battery is "acid-starved." This feature:

- limits the discharge the plates can deliver.
- protects the plates from shedding due to deep discharge.
- extends the life of the battery.

Why do EPM VRLA batteries have longer cycle life than others?

Some of the major features that contribute to our long cycle life are:

- Our patented calcium/copper grid alloy **delivers superior performance** due to the purity of the lead. Copper is added as a "grain refiner." This means that the microscopic grains in our lead grids are odd-shaped, so they retard corrosion and **extend the life** of our grid.
- Our **thicker grids** have more corrosion resistance than thinner grids.

- Our VRLA batteries are protected against deep discharge because they are "**acid-starved**." This means that the battery uses the power in the acid before it uses the power in the plates. Therefore, the **plates are never subjected to destructive ultra-deep discharges**.
- With proper temperature-sensing, voltage-regulated charging (refer to table on page 11) the VRLA battery **never runs out of water**.
- Our gel batteries contain ultra-premium, **glass-mat**, dual-insulating separators which will not break down in service. The glass mat embeds itself into the plate, which **retards life-shortening shedding**.
- Our gel batteries contain polyester element wrap which **retards "mossing"** or active material growth that causes short circuits.
- Our AGM batteries contain separators at the ideal compression and ideal saturation to achieve the best balance between capacity utilization and recombination efficiency.
- Over **250 quality control checks** assure superior performance and long battery life.

Why do EPM VRLA batteries have longer shelf life?

Our calcium/copper lead alloy premium separators and demineralized electrolyte are **ultra-pure**. Impurities in the lead alloy, separators and electrolyte cause tiny currents inside a cell which eventually discharge the battery and shorten its shelf life. **The purer the components, the longer the shelf life**. No one can match East Penn's purity!

Our exclusive "**weld seal gasket**" blocks the minute cell-to-cell currents that cause self-discharge. The better the weld seal, the longer the shelf life. Weld seals are **exclusive** to East Penn VRLA batteries.

Does depth of discharge affect cycle life?

Yes! The harder any battery has to work, the sooner it will fail.

Capacity Withdrawn	Typical Life Cycles	
	Gel	AGM
100%	450	150
80%	600	200
50%	1000	370
25%	2100	925
10%	5700	3100

* You may experience longer or shorter life based upon application, charging regimen, temperature, rest periods, type of equipment, age of battery, etc.

As you can see, **the shallower the average discharge, the longer the life**. This is why it's important to size a battery system to deliver at least twice the average power required, to assure shallow discharges.

Follow these tips for the longest life:

- Avoid ultra-deep discharges.
- Don't leave a battery at a low stage of charge for an extended length of time. Charge a discharged battery as soon as possible.
- Don't cycle a battery at a low state of charge without regularly recharging fully.
- Use the highest initial charging current available (up to 30% of the 20-hour capacity per hour) while staying within the proper temperature-compensated voltage range.

Why can't EPM VRLA batteries be discharged too low?

Our VRLA batteries are designed to be "acid-starved." This means that the power (sulfate) in the acid is used before the power in the plates. This design protects the plates from ultra-deep discharges. Ultra-deep discharging is what causes life-shortening plate shedding and accelerated positive grid corrosion which can destroy a battery.

Why does temperature have such a dramatic effect on batteries?

Temperature is a major factor in battery performance, shelf life, charging and voltage control. At higher temperatures there is dramatically more chemical activity inside a battery than at lower temperatures. The following charts graphically illustrate this fact.

Typical Self-Discharge of VRLA Batteries at Different Temperatures

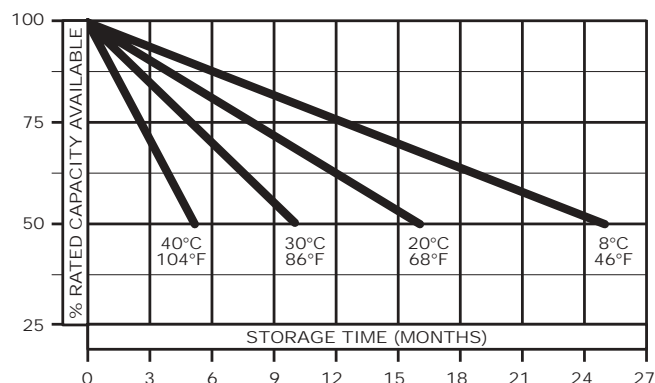

AGM Charge and Float Voltages at Various Temperature Ranges

Temp. °F	Charge		Float		Temp. °C
	Optimum	Maximum	Optimum	Maximum	
≥ 120	13.60	13.90	12.80	13.00	≥ 49
110 – 120	13.80	14.10	12.90	13.20	43 – 49
100 – 110	13.90	14.20	13.00	13.30	38 – 43
90 – 100	14.00	14.30	13.10	13.40	32 – 38
80 – 90	14.10	14.40	13.20	13.50	27 – 32
70 – 80	14.30	14.60	13.40	13.70	21 – 27
60 – 70	14.45	14.75	13.55	13.85	16 – 21
50 – 60	14.60	14.90	13.70	14.00	10 – 16
40 – 50	14.80	15.10	13.90	14.20	4 – 10
≤ 40	15.10	15.40	14.20	14.50	≤ 4

Gel Charge and Float Voltages at Various Temperature Ranges

Temp. °F	Charge		Float		Temp. °C
	Optimum	Maximum	Optimum	Maximum	
≥ 120	13.00	13.30	12.80	13.00	≥ 49
110 – 120	13.20	13.50	12.90	13.20	44 – 48
100 – 109	13.30	13.60	13.00	13.30	38 – 43
90 – 99	13.40	13.70	13.10	13.40	32 – 37
80 – 89	13.50	13.80	13.20	13.50	27 – 31
70 – 79	13.70	14.00	13.40	13.70	21 – 26
60 – 69	13.85	14.15	13.55	13.85	16 – 20
50 – 59	14.00	14.30	13.70	14.00	10 – 15
40 – 49	14.20	14.50	13.90	14.20	5 – 9
≤ 39	14.50	14.80	14.20	14.50	≤ 4

What is acid stratification? How do VRLA batteries prevent it?

See page 6 for a detailed explanation of this phenomenon.

How does a battery recharge?

The process is the same for all types of lead-acid batteries: flooded, gel and AGM. The actions that take place during discharge are the reverse of those that occur during charge.

The discharged material on both plates is lead sulfate (PbSO₄). When a charging voltage is applied, charge flow occurs. Electrons move in the metal parts; ions and water molecules move in the electrolyte. Chemical reactions occur at both the positive and negative plates converting the discharged material into charged material. The material on the positive plates is converted to lead dioxide (PbO₂); the material on the negative plates is converted to lead (Pb). Sulfuric acid is produced at both plates and water is consumed at the positive plate.

If the voltage is too high, other reactions will also occur. Oxygen is ripped from water molecules at the positive plates and released as a gas. Hydrogen gas is released at the negative plates—unless, oxygen gas can reach the negative plates first and "recombine" into H₂O.

A battery will "gas" near the end of charge because the charge rate is too high for the battery to accept. A temperature-compensating, voltage-regulating charger, which automatically reduces the charge rate as the battery approaches the fully charged state, eliminates most of this gassing. **It is extremely important not to charge batteries for long periods of time at rates which cause them to gas** because they use water, which in sealed valve-regulated batteries cannot be replaced. Of course, no battery should be overcharged for a long period of time...even at low rates using so-called "trickle charges."

In a fully charged battery, most of the sulfate is in the sulfuric acid. As the battery discharges, some of the sulfate begins to form on the plates as lead sulfate (PbSO₄). As this happens, the acid becomes more dilute, and its specific gravity drops as water replaces more of the sulfuric acid. A fully discharged battery has more sulfate in the plates than in the electrolyte.

The following illustration shows the relationship between specific gravity readings and the combination of the sulfate from the acid with the positive and negative plates at various states of charge.

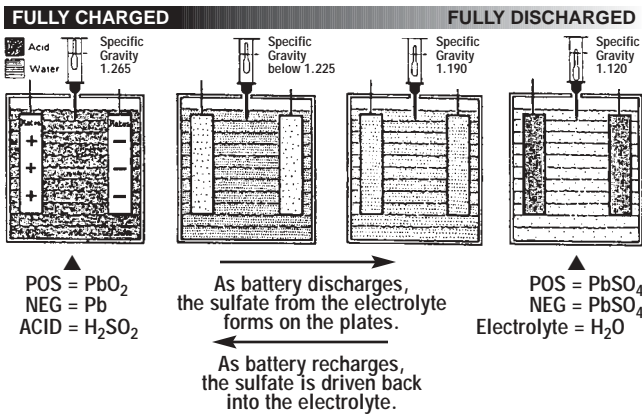

How critical is recharge voltage? Why are all VRLA batteries so charge sensitive?

All lead-acid batteries give off hydrogen from the negative plate and oxygen from the positive plate during charging.

VRLA batteries have pressure-sensitive valves. Without the ability to retain pressure within the cells, hydrogen and oxygen would be lost to the atmosphere, eventually drying out the electrolyte and separators.

Voltage is electrical pressure. Charge (ampere-hours) is a quantity of electricity. Current (amperes) is electrical flow (charging speed). A battery can only store a certain quantity of electricity. The closer it gets to being fully charged, the slower it must be charged. Temperature also affects charging.

If the right pressure (voltage) is used for the temperature, a battery will accept charge at its ideal rate. If too much pressure is used, charge will be forced through the battery faster than it can be stored. Reactions other than the charging reaction occur to transport this current through the battery—mainly gassing. Hydrogen and oxygen are given off faster than the recombination reaction. This raises the pressure until the pressure relief valve opens. The gas lost cannot be replaced. Any VRLA battery will dry out and fail prematurely if it experiences excessive overcharge. **Note:** It is the pressure (voltage) that initiates this problem—a battery can be “over-charged” (damaged by too much voltage) even though it is not fully “charged.”

This is why charging voltage must be carefully regulated and temperature compensated to the values on page 11.

How long does it take to recharge a fully discharged VRLA battery?

A specific time is difficult to determine because recharging depends on so many variables:

- Depth of discharge
- Temperature
- Size and efficiency of the charger
- Age and condition of the battery

See the following Charging Guides for an estimated time based upon the initial charge current the battery accepts.

Typical Charging Time vs. 90% and 100% State of Charge

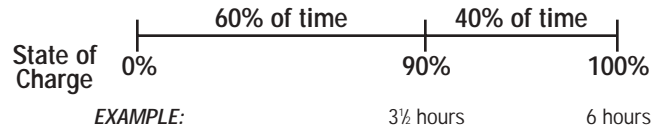

It will take about 60% of the charge time to bring a VRLA battery from 0% charged to 90% charged. It will take the remaining 40% of the total charging time to put the last 10% of the charge back into the battery.

Charge is a quantity of electricity equal to rate of flow (Amperes) times time (hours), and usually expressed in Ampere-hours (Ah).

0% state of charge is defined as the depth of discharge giving a terminal voltage of 10.50 Volts – measured under a steady load at the 20-hour rate at 80°F. (The 20-hour rate is the 20-hour capacity divided by 20 hours.)

Typically, the charge that must be returned to a VRLA battery to achieve a 100% state of charge is from 105% to 115% of the charge removed.

Charging Guides

Typical Charge Time vs. Initial Charge Current to 90% Full Charge

(Using an automatic temperature-sensing, voltage-regulating charger set at 13.8V. Totally discharged battery at 11.80–12.0 volts.)

Part No.	Initial Amperes		
	13 hrs*	6 hrs*	3 1/2 hrs*
8GU1, 8GU1H, 8AU1, 8AU1H	3	8	15
8G22NF, 8A22NF	5	12	23
8G24, 8A24	7	17	33
8G27, 8A27	8	21	41
8G30H, 8G31, 8G31DT, 8A30H, 8A31, 8A31DT	9	24	45
8G4D, 8GGC2, 8A4D, 8AGC2	17	42	83
8G8D, 8A8D	20	50	100

*approximate

HOW TO USE THIS CHART: When charger is first turned on, read amps after about one minute. Initial ampere reading will indicate approximate charging time.

EXAMPLE

If an 8G24 reads about 17 ampere charge current when first turned on, the battery will be at 90% in about 6 hours.

IMPORTANT: Always use an automatic temperature-sensing, voltage-regulated charger! Set charger at 13.8 to 14.1 volts at 68°F for gel, or 14.4 to 14.6 volts at 68°F for AGM. Do not exceed 14.1 volts for gel or 14.6 volts for AGM.

How can continual undercharging harm a battery?

In many respects, **undercharging is as harmful as overcharging**. Keeping a battery in an undercharged condition allows the positive grids to corrode and the plates to shed, dramatically shortening life. Also, an undercharged battery must work harder than a fully charged battery, which contributes to short life as well.

An undercharged battery has a greatly reduced capacity. It may easily be inadvertently over-discharged and eventually damaged.

How can you tell if an VRLA battery is fully charged?

By using a voltmeter.

% Charge	Open Circuit Voltage		
	Flooded	Gel	AGM
100	12.60 or higher	12.85 or higher	12.80 or higher
75	12.40	12.65	12.60
50	12.20	12.35	12.30
25	12.00	12.00	12.00
0	11.80	11.80	11.80

NOTE: Divide values in half for 6-volt batteries.
** The "true" O.C.V. of a battery can only be determined after the battery has been removed from the load (charge or discharge) for 24 hours.*

How can you tell if a VRLA battery has been damaged by under- or overcharging?

The only way is **with a load test**. Use the same procedure you would use with a wet cell battery:

- Recharge if the open circuit voltage is below 75%.
- If adjustable, set the load at $\frac{1}{2}$ the CCA rating or three times the 20 hour rate.
- Apply the load for 15 seconds. The voltage should stabilize above 9.6 volts while on load.
- If below 9.6 volts, recharge and repeat test.
- If below 9.6 volts a second time, replace the battery.

What is a float charger? What float voltage is recommended?

This type of charger continually delivers a pre-set voltage to the battery, regardless of charge conditions.

These chargers are used in stationary, emergency back-up power, emergency lighting, and other applications.

The frequency of discharge and temperature will dictate a more exact setting. For example, the more frequent the discharge, the higher the suggested recharge voltage, to a **maximum of 2.35 volts per cell (at 20°C/68°F)**.

Our recommended float voltage is 2.25 to 2.3 volts per cell for gel and absorbed models.

What is a thermal runaway?

The appropriate charge voltage depends on the battery temperature (see page 11). A warmer battery requires a reduced voltage. If the voltage is not reduced, current accepted by the battery increases. When the current increases, the heating increases. This can continue in a loop feeding on itself with the battery temperature and charging current rising to destructive levels.

Gel batteries are much less susceptible to thermal runaway than AGM batteries. Batteries may become more susceptible with increasing age. Without a recombination reaction, flooded batteries convert most excess charging energy to gas, not heat. This makes them almost immune from the thermal runaway.

Thermal runaway can be prevented with:

- Temperature compensation monitoring at the battery—not at the charger.
- Limiting charging currents to appropriate levels (see page 11).
- Allowing for adequate air circulation around the batteries.
- Using timers, or Ampere-hour counters.
- Using smart chargers that recognize the signature of a thermal runaway event which will shut the charger down.

How do I know if a charger is "gel friendly" or "AGM friendly"?

Unfortunately, many chargers on the market claim to be gel "friendly" or "OK for sealed batteries", but are not. Some overcharge the batteries, while others may not fully charge the batteries. Some chargers claim to be "smart". Some "smart" chargers do a good job, others do not. The best choice of charger often depends on the application.

Use only "voltage-regulated" or "voltage-limited" chargers. **Standard constant current or taper current chargers must not be used. The voltage must fall in the range of the chart on page 11.** Almost all applications require temperature sensing and voltage compensation. Beware, many chargers measure the ambient temperature which could be significantly different from the battery's internal temperature.

Low frequency current ripple (to about 333 Hz) can be detrimental to sealed batteries depending on the application. On applications where the charger is connected continuously to a float voltage, especially where simultaneous charge and discharge may occur, the level of current ripple must be a consideration.

If you are not sure if a charger is performing properly, follow this procedure:

- Using a fully discharged VRLA battery (OCV about 11.8V) and a digital voltmeter, record the initial open circuit voltage at the battery terminals.
- Using an automatic charger as described above, set voltage if adjustable (14.1V for gel, 14.4V for AGM models).
- Connect and start charging. Record initial on-charge voltage and current.
- Each hour or so, check and record the on-charge voltage across the battery terminals. Except for occasional, brief "blips" or pulses, the voltage should not exceed the voltage limits noted in "b" above.

- e. At the end of charge (when the current is very low or goes to zero) check and record the voltage. Note that the charger may have turned off by then.
- f. The disconnected battery should be at 100% or above after a 24 hour rest.

During the charging time, the charger should not have exceeded the limit (except for occasional, brief pulses). This indicates that the charger is working properly.

Keep in mind that the voltage limit is at 68°F/20°C. Charging at higher or lower temperatures will change this limit.

A temperature-sensing charger should always be used, as manual adjustments are never accurate and will damage any VRLA battery.

Do VRLA batteries have a "memory" like ni-cad batteries?

One of the major disadvantages of nickel-cadmium (ni-cad) batteries is that after shallow discharge cycles, the unused portions of the electrodes "remember" the previous cycles and are unable to sustain the required discharge voltage beyond the depth of the previous cycles. The capacity is lost and can only be restored by slowly discharging completely (generally outside the application), and properly recharging. **VRLA batteries do not exhibit this "use it" or "lose it" capacity robbing effect known as memory.**

What is a safe charge rate or voltage setting for outdoor applications with wide temperature fluctuations if a temperature-sensing charger is not available?

NONE! As the chart on page 11 (Effect of Temperature on Recharge Voltage) shows, charging voltage varies widely with temperature. **There is no fixed voltage setting or current that will work.** A temperature-sensing, voltage-regulated charger must be used. Anything else will damage any battery and **cause premature failure!**

Can a VRLA battery be load tested?

Yes. See page 13 (How can you tell if a VRLA battery has been damaged by under- or overcharging?).

Why do some VRLA batteries bulge? Why do some VRLA batteries appear "sucked in"? Are there visual signs of a faulty or plugged pressure relief valve?

To prevent the permanent loss of gases so that recombination has time to take place, each cell can hold up to about 1.5 psi without venting.

Batteries with very large cells, such as the 8G4D, 8G8D, 8A4D, 8A8D and 8GGC2, will bulge somewhat as this normal pressure builds. This is especially true in higher temperatures, because the polypropylene case is pliable. Therefore, **a certain amount of bulge is normal.**

The valves only let gas out, never in. A partial vacuum can form within a sealed battery under various circumstances. Battery temperature and ambient pressure play a role, but predominantly the recombination and discharge reactions are responsible. After charging ends, the recombination reaction continues until most of the oxygen in the battery headspace is consumed. The total volume of the battery components decreases slightly during a discharge. Deeply discharged batteries often have a "sucked-in" appearance. Batteries with large cells may display this appearance even when fully charged.

If a battery bulges severely on charge, this is not normal. It is an indication of a blocked valve or an overcharge situation. Such a battery should be removed from service.

A sucked-in appearance can also be normal. A sucked-in battery should be charged, but if it remains sucked-in after charging, the appearance can safely be ignored; however, if only a single cell displays or lacks this appearance a load test would be prudent.

How safe are VRLA batteries? Can they explode?

VRLA batteries are very safe, unless abused. However, as with any type battery, certain safety precautions must be taken.

ALWAYS WEAR SAFETY GLASSES WHEN WORKING AROUND BATTERIES!

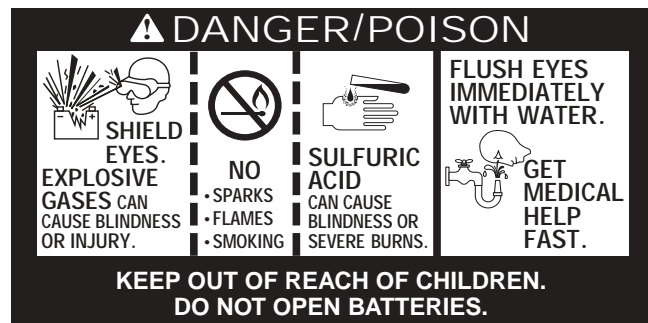

CALIFORNIA PROPOSITION 65 WARNING: Batteries, battery posts, terminals and related accessories contain lead and lead compounds and other chemicals known to the state of California to cause cancer and birth defects or other reproductive harm. **Wash hands after handling.**

Because VRLA batteries normally emit very little to no hydrogen gas, they are safe near sensitive electronic equipment. They do not cause corrosion of surrounding metals. No hydrogen gas means no dangerous explosions... **UNLESS SEVERELY OVERCHARGED!**

Do not install any lead-acid battery in a sealed container or enclosure. Hydrogen gas from overcharging must be allowed to escape.

**DO NOT CHARGE IN EXCESS OF 14.1V @ 68°F - Gel Cells
14.6V @ 68°F - Absorbed**

Always use a reliable, temperature-sensing, voltage-regulated, automatic charger.

Because SVR batteries have immobilized electrolyte, they cannot spill or leak, even if punctured. That is why they are approved for air transport by the International Commercial Airline Organization (ICAO), International Airline Transport Association (IATA), and Department of Transportation (DOT) as noted on the label if properly insulated from short circuits.

Also, when protected against short circuits and securely braced/ blocked, our VRLA batteries “are not subject to any other requirements of 49 CFR Parts 171-180...” for shipping.

Which way does current flow? On which side should a circuit breaker be installed?

During discharge, electrons progress through the external circuit from the negative post toward the positive post. Inside the battery, positive ions move toward the positive plate by diffusion where they react, leaving neutral molecules in solution. The resulting neutral molecules move back toward the negative plate by diffusion. There are also negative ions in the electrolyte offsetting the positive ion charges. Some travel by diffusion toward both the negative and the positive plates, where they are consumed. During charge, all of the directions reverse.

Although not physically accurate, when designing circuits or making calculations, it is just as valid to consider positive charges moving through the whole circuit. Indeed, this is the convention used to define the direction of current in electronics (known as conventional current).

Proper location of disconnects depends on the application.

Vehicles can vary, but in most cases, the negative terminal is treated as ground. The entire chassis is connected to the negative terminal of the battery. The positive side of the circuit is considered “hot.”

Switches/circuit breakers should usually be installed on the hot side of a device. When disconnecting the entire battery from the system with a fusible link or circuit breaker, breaking the connection from the negative terminal to the chassis often works best.

In multiple battery installation, there could be other considerations such as total voltage, multiple voltages, and the effects on other devices.

What do I need to know about installation, especially in salt water marine applications?

Wiring and Waterproofing

ALWAYS WEAR SAFETY GLASSES WHEN WORKING AROUND BATTERIES!

- Cabling of the approved gauge should be tinned copper. If using untinned copper, allow plenty of spray silicone to “wick” along the strands.
- Install heat-shrink tubing with a silicone interior; the silicone forms an excellent moisture barrier. Cut the tubing long enough to cover the terminal lug and plenty of the insulated portion of the cable. Slip tubing onto the cable.
- Crimp on the appropriate terminal.
- Position the heat-shrink tubing. Heat and inspect.
- Clean battery terminals and connect. Be sure perfect metal-to-metal contact is made, with no dirt, corrosion, grease or foreign material to interfere with current flow.
- Always attach the cable connected to the solenoid or starter first. Attach the ground cable last! Tighten snugly, BUT DO NOT OVERTIGHTEN, which will damage the terminals or crack the battery cover. This will destroy the battery and VOID THE WARRANTY.

g. Spray exposed terminals and connectors with several coats of battery terminal corrosion protection spray. (Mask surrounding areas to protect against overspray.)

h. For batteries which may be exposed to very wet environments (e.g. bilge mounted batteries) total encasement of the exposed terminals and connectors is necessary. However, do not block or cover the vents. **Allow ventilation.**

A battery terminal boot should be used. Install the boot on the cable before crimping the terminal. Fill the boot with petroleum jelly and fit over the sprayed connectors (as in “g” above).

i. Battery charging in a boat requires a charger specifically designed for marine applications. In addition to battery gases, bilges often contain potentially dangerous fuel fumes. Follow all wiring and grounding recommendations of the charger manufacturer for on-board and on-shore connections.

Using a charger not specifically designed for marine applications or failure to follow the marine charger manufacturer’s grounding and wiring recommendations could result in major corrosion damage to the hull or prop, and create a serious risk of electrical shock or fire, personal injury or death.

Battery Installation

Note: In a multi-battery installation, it is often best to replace the entire set of batteries when one battery is weak or has failed.

Series

A “series” system increases the voltage, but keeps the battery capacity (cranking amps, amp hours, reserve minutes, and minutes running time) the same. Therefore, two 12-volt batteries connected in series (POS to NEG, NEG to POS) will deliver 24 volts at the same rating as one battery: During recharge, each battery receives the same amount of current; e.g. if the charger is putting out 10 amps, both batteries are getting 10 amps.

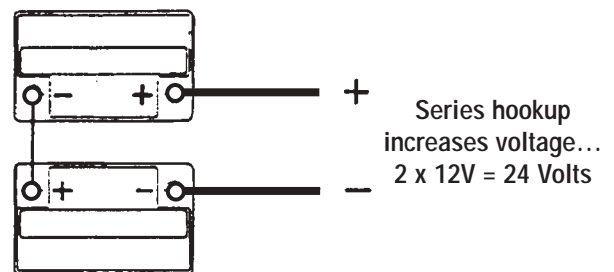

Parallel

A “parallel” system increases the capacity available, but keeps the voltage the same. Therefore, two 12-volt batteries with 400 CCA, 110 R.C. and 65 Ah will deliver 12 volts, 800 CCA, 220 R.C. and 130 Ah. (Actually, since each battery’s load is lighter, the reserve capacity will more than double.)

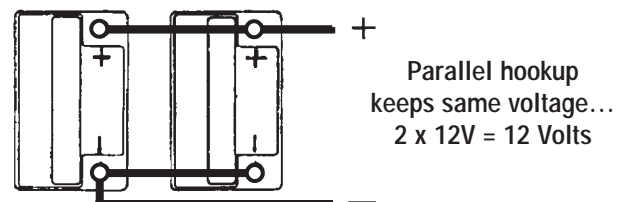

During recharge, the current (amps) is split between the batteries. The battery that is discharged the most will receive more current than the other until both are brought up to full charge.

Series/Parallel

A "series/parallel" system provides a combination of voltage and capacity for special applications. Note: Never mix different types and sizes of batteries in the same bank.

Dual Voltage

The illustration shows an arrangement that would supply 24 volts to a starter and 12 volts to the electronics (or vice versa).

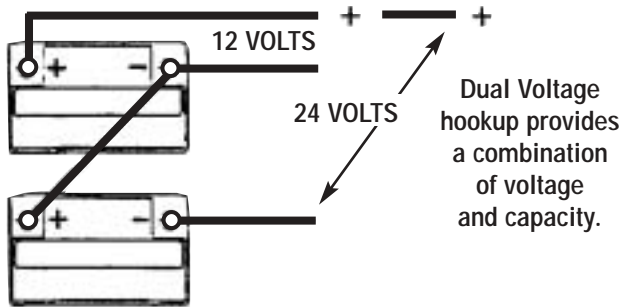

To properly recharge, a sophisticated "battery isolator" should be installed. Otherwise, one battery will be continually overcharged and the other undercharged in a dual-voltage set-up.

IMPORTANT: Do not install any type of battery in a completely sealed box or enclosure. In the event of overcharging, the potentially explosive gasses must be allowed to escape.

MEMBER OF:



DISCLAIMER: By providing this information, East Penn, its employees and distributors make no representation or warranties about the information provided in this document. All content is provided without warranties, express or implied. East Penn and its representatives are not to be held liable for any and all damages whatsoever in using or interpreting the information in this document, whether suitable or not.

"POWERED FOR PERFORMANCE"™

EAST PENN manufacturing co., inc.

Lyon Station, PA 19536-0147 • Phone: 610-682-6361 • Fax: 610-682-4781

Order Department Hotline: 610-682-4231

www.eastpenn-deka.com

E-mail: eastpenn@eastpenn-deka.com

E.P.M. Form No. 0139 Rev. 3/04
© 2004 by EPM Printed in U.S.A.

DISTRIBUTED BY:

No part of this document may be copied or reproduced, electronically or mechanically, without written permission from the company.