



**OPERATING
MANUAL**



Super 8 ForU





Introduction

With the **Super 8** ForU , you have now purchased a product which has been manufactured in accordance with the newest technical capabilities and based on the highest operating comfort. We have placed great value on the simplest possible operation and long service life in both construction and material selection. A large variety of useful accessories rounds off our range in addition to the **ForU** scooter.

This Operating Manual assumes that the suitability of the user for scooter usage has been discussed with a doctor, therapist and/or dealer before operation.

The operating manual will help you get to know the function of our ForU scooter and, in addition, describes

- operation
- care and maintenance
- repair

The manual has been drawn up using information available at the time of printing with regard to construction and operation of the scooter. We reserve the right to make changes due to technical improvements.

If you have any other questions about this scooter please contact your retailer or supplier.

Contents

1.0 Safety instructions	8
1.1 Symbols used	8
1.2 Intended use	8
1.3 General Information	9
1.4 Safety when driving	10
1.5 Safety during transport, assembly and maintenance	11
1.6 Safety when handling batteries	12
1.7 Safety - information about electronics.....	12
2.0 Versions	13
3.0 Extent of delivery	13
4.0 Components	14
4.1 The Midi XMB scooter	14
4.2 The dashboard - displays and controls	14
5.0 Brief instructions	15
5.1 Driving	15
5.2 Transporting the scooter.....	17
6.0 Setting up the scooter	19
6.1 Adjusting the seat height	19
6.2 Adjusting the seat position	21
6.2.1 Adjusting the distance between seat and tiller	21
6.2.2 Adjusting the armrest width	21
6.2.3 Adjusting the armrest height	22
6.3 Adjusting the tiller angle	23
7.0 Information about safe driving	24
7.1 Driving up inclines and down slopes	25
7.2 Overcoming obstacles	26
7.2.1 Driving Information – Overcoming kerbs	27
7.3 Overload protection - motor protection	28
7.4 Battery charging state = driving range	29
7.4.1 Battery charging state	29
7.4.2 Driving range	30
7.4.3 Overdischarge protection - battery protection	30
8.0 Driving	31
8.1 Getting on and off	31
8.2 Turning the seat	33
8.3 Switching on	33
8.3.1 Operation indicator and fault display	33
8.5 Adjusting the speed	34
8.6 Before driving	34

Contents

8.7	Driving	35
8.8	Using the motor brake	35
8.9	Using the horn	36
8.10	Switching off / parking	36
9.0	Pushing	37
10.0	Attaching the shopping basket	37
11.0	Charging the batteries	38
11.1	Charging the batteries	39
11.1.1	Charging the batteries in via the tiller	39
11.1.2	LED information at battery charger during charging	40
11.2	After charging	40
	Things to know	41
12.0	12.1 The battery charger - functioning principle	41
	12.2 The Batteries	41
	12.2.1 What are batteries for cyclic use?	42
	12.2.2 When do the batteries achieve their maximum performance?	42
	12.2.3 How do I make sure the batteries achieve their best service life?	42
	12.3 Anti tipping wheels	42
	12.4 Wheels and tyres	42
	12.5 The drive unit	43
	12.6 The working principle	43
	12.7 The control unit	44
	12.8 The auto switch-off	44
	12.9 Brakes	44
	12.10 Driver's licence	45
	12.11 Insurance	45
	12.12 Approval for road traffic use	45
	Transporting the scooter	46
13.0	13.1 Transport information	46
	13.2 Transporting the complete scooter	46
	13.3 Preparation for transport - separating components	46
	13.3.1 Working step summary	47
	13.3.2 Removing the seat	47

Contents

13.3.3	Removing the batteries	47
13.3.4	Folding the tiller down	48
13.3.5	Disengaging the drive unit from the chassis	48
	Cleaning	49
	Maintenance and Inspection	50
15.1	Daily maintenance before start of journey	50
15.3	Annual inspection - inspection timetable	51
	Troubleshooting	54
16.1	Before troubleshooting	54
16.2	Troubleshooting	55
16.3	Operation indicator blink codes	57
16.3.1	Blink list	57
	Repairs	58
17.1	Information about safety at work	58
17.2	Tools	58
17.3	Wheels - removal and replacement.....	59
17.5	Replacing the tyre	62
17.6	Fuses	63
17.7	Batteries	64
17.7.1	Disposal of used or damaged batteries	64
17.7.2	Refitting battery cables	64
	18.0 Temporary storage	66
	Appendix	67
19.1	Specifications	68
19.1.1	General data	68

Contents

19.2 Torque for fixing screws	69
19.3 Disposing of the scooter	69
20.0 Warranty information	69
Work shop use only.....	70

1.0 Safety instructions

1.1 Symbols used

This instruction manual contains the following symbols which are used to highlight special hazards in dealing with the product or information for simplifying the handling.



Caution!

This symbol identifies safety information which notifies you of hazards when dealing with the product.



NOTE

You will also find information about dealing with the product under this symbol.

1.2 Intended use

The **KYMCO Healthcare** scooter is constructed for use both **indoors (Suggest general use - indoors)**and outdoors .

It is intended to increase the mobility of persons who are both physically and mentally capable of assessing any driving situations correctly and reacting correspondingly to them at any time.

The Super 8 models are classified as an “invalid carriage” for use indoors, on pavements, footpaths, pedestrian zones and areas free from motor traffic.

They must not be driven on public roads with the exception of crossing or when no pavements are available.

1.3 General Information

Read the entire operating manual thoroughly before using the Super 8 ForU!

Ensure that:

- the operating manual is read by all people who drive, care for and service the scooter.
- all persons who drive, care for, service or repair the scooter have access to the operating manual at any time.

Any damages resulting from nonobservance of this operating manual are excluded from the guarantee.



Risk of accidents!

- Do NOT use the scooter if your driving capability is impaired through consumption of medicine or alcohol.
- Only use the scooter for its correct intended use.
- Only use the scooter when it is in perfect working order.
- If any breakdowns occur, stop using the scooter immediately and secure it against unauthorized use.
- It is imperative that you always rectify any faults which could influence the function and safety of the scooter immediately.
- Observe maximum loading = see Specifications
- Only use accessories and spare parts authorized by **KYMCO Healthcare** UK Limited.
- The scooter is only authorized for transport of one person.
- Do not carry out any seat adjustments while driving.



Tipping hazard!

- Do not adjust the seat if the scooter is standing on an incline.
- Do not lean out over the armrest to the sides or over the backrest to the rear.

1.4 Safety when driving



Risk of accidents!

- Check correct functioning of the brakes before every journey.
- Check the tyre air pressure regularly.
- Always use the seat belts when driving.
- Do not switch the scooter off while driving.
- Do not drive up or down gradients which are too steep, over obstacles on gradients or up and down ramps. Observe maximum climb angle = see Specifications
- Only drive through restricted widths, around bends, inclines and ramps with reduced suitable speed.
- Only drive up or down inclines when the backrest has been adjusted to vertical.
- Don't drive too close to open waters.



Tipping hazard!

- Do not carry out any seat adjustments while driving.
- Only drive over obstacles and up kerbstones at the lowest point and at right angles.
- Avoid sudden changes of direction and speed.
- Avoid steep gradients where there is a danger of skidding (ice, snow, wet surfaces etc.).
- Avoid loose surfaces whose characteristics you are not able to assess (woodlands, turf, beaches, gravel etc.)
- Always drive straight up and down gradients - do not drive in zigzags.
- Do not turn around on inclines.
- Do not drive down steps.
- Do not drive backwards down gradients, stairs or kerbstones, or over obstacles.



Danger due to unintentional movement!

- Always turn the scooter off using the keyswitch if you:
 - want to get on or off
 - intend to stop for long periods
 - are putting the scooter away.

1.5 Safety during transport, assembly and maintenance



If the scooter is transported in the vehicle when fully assembled:

- **no persons may sit on the scooter during loading!**
- **no persons may sit on the scooter during transport!**



Clamping and crushing hazard!

Increased hazards due to clamping or crushing result due to the high component weight (such as batteries) during preparation for transport and maintenance work.

- Always carry out any work to be done with great care.
- Always try to get help from a second person, especially when stowing parts for transport.
- Only carry out any work described if you are used to working with the tools required.
- Only carry out work using suitable tools.



Injury hazard due to improper assembly!

- Ensure that all components in the Scooter have been correctly assembled.
- After assembly, check that all locking devices are holding correctly.



Accident hazard due to incorrectly bolted connections!

- If bolted connections have self-locking nuts, ensure that these are replaced when reassembling.
- Do not replace self-locking nuts with normal nuts.
- If bolted connections have lock washers, check lock washers when reassembling and replace if necessary.

1.6 Safety when handling batteries



Fire hazard!

- Do not cover the battery charger and ventilation slot while charging batteries.
- Only use the battery charger in well-ventilated areas.



Risk of accidents!

- Only use the original battery charger (included in delivery).
- Let your dealer replace your battery.
- Only use batteries as detailed in the chapter entitled "Specifications".
- Observe warning information given by the battery manufacturer.
- Batteries are extremely heavy.



Burn hazard due to damaged batteries!

Batteries discharging acid can lead to serious burns.

- Do not touch damaged batteries with your bare hands. Use rubber gloves!
- If acid should contact your skin, wash the affected area immediately with plenty of water and contact a doctor.
- If acid should come in contact with your eyes, rinse them out immediately with lots of water and visit a doctor.
- Always change any clothing soiled with battery acid immediately.

1.7 Safety - information about electronics



Accident hazard due to failures!

Radio, television, radio transmission devices and mobile phones produce electromagnetic fields. These can negatively influence the scooter electronics functions.

- Do not drive close to strong radio or television transmitters (transmitter masts).
- Switch the scooter off if you are using your mobile phone.



Interference caused to other devices!

The scooter produces an electromagnetic field which can negatively affect functioning of electrical devices such as medicinal devices, radio receivers or mobile telephones within the vicinity.

2.0 Versions



3.0 Extent of delivery

After receiving your ForU scooter, please check the following:

- that the delivery is complete in accordance with the list below
- the delivery condition using the inspection plan (chapter 14.2)

If any faults are apparent or components are missing, please contact your supplier or dealer.

The following items are included in delivery in addition to the scooter:

1. Shopping basket
2. Two vehicle keys for switching the on/off
3. Battery charger
4. Operating Manual



4.0 Components

4.1 The ForU scooter

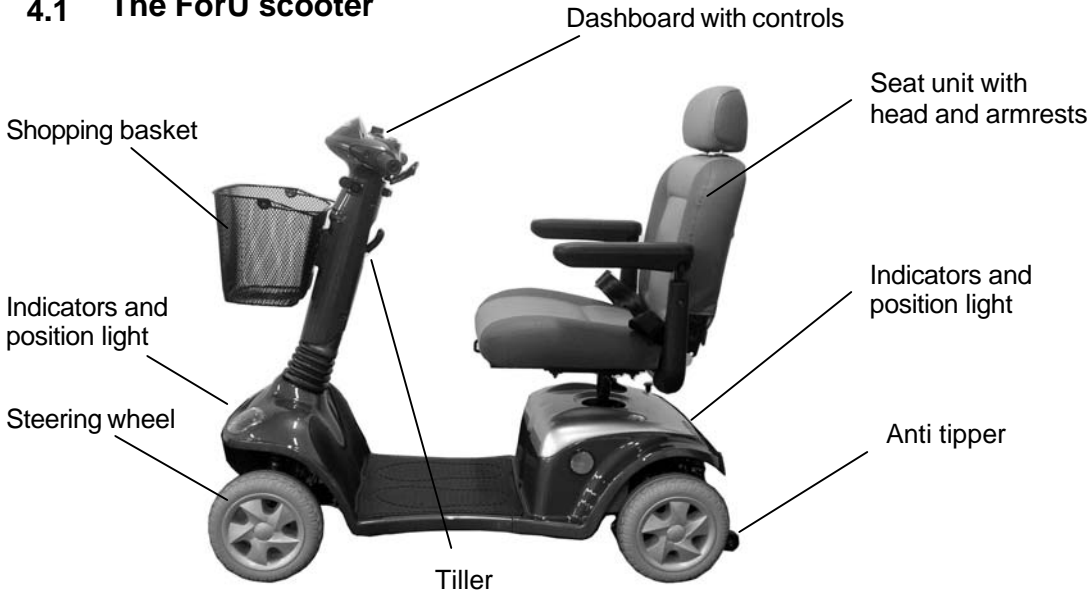

4.2 The dashboard - displays and controls

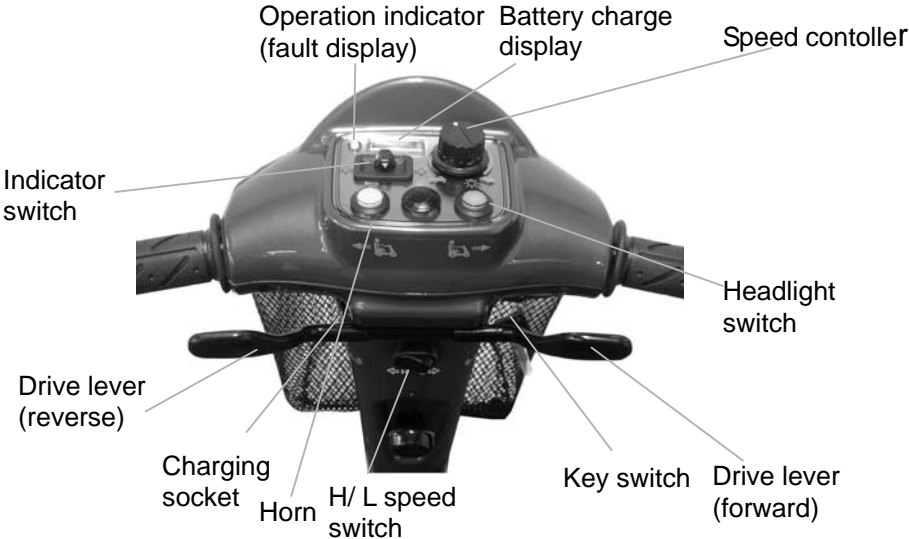

5.0 Brief instructions

The following brief instructions should enable people to quickly get used to operating the scooter after a long period of non-use and to refresh existing knowledge of operation.

It is imperative that you follow the instructions given in the main manual!

5.1 Driving the scooter



NOTE

Before starting driving, adjust the seat height, the backrest and the armrests to a comfortable position.

Your specialist dealer would be very glad to help.

1.) Turn the seat to the outside.



2.) Get in - turn the seat in the direction of travel



3.) Switch on the scooter



Brief instructions

4.) Check the battery charging state

Red-reserve
Yellow-medium
Green-full

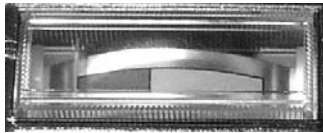

5.) Set the maximum speed



 = lowest possible driving speed (approx. 4mph)

 = highest possible driving speed (approx. 6mph)

6.) Driving

Operate the drive lever slowly until the required speed has been reached

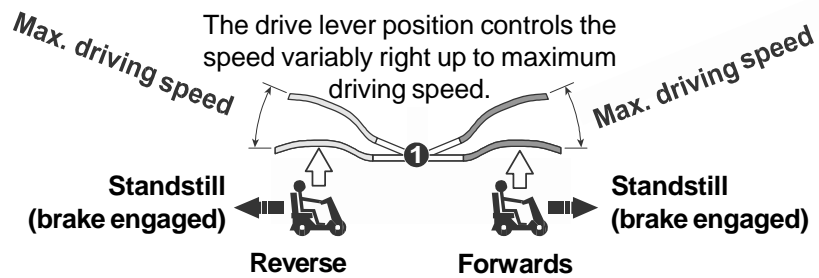

7.) Braking = release drive lever (1)

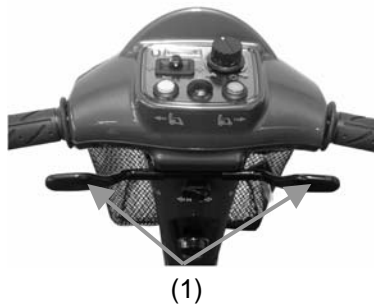

8.) Horn 9.) position light

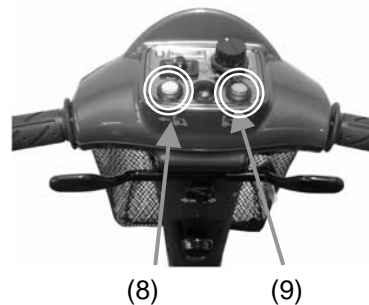

5.2 Transporting the scooter

Dismantling the SCOOTER (stages 1 to 9)

1.) Remove the seat



2.) Removing the rear panelling

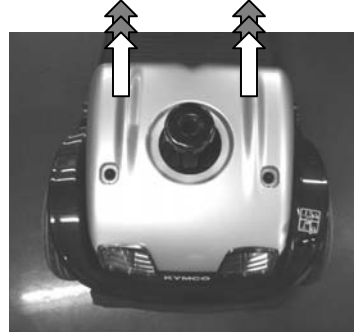

3.) Remove the lighting cable

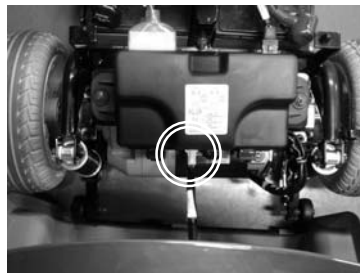

4.) Remove the battery plug and front connector

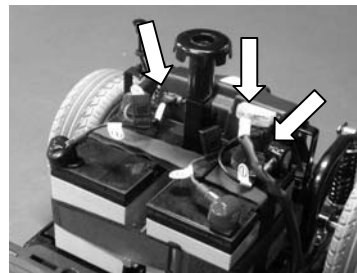

5.) Remove the battery belts and batteries

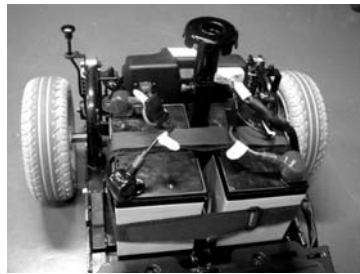

6.) Fold the tiller down

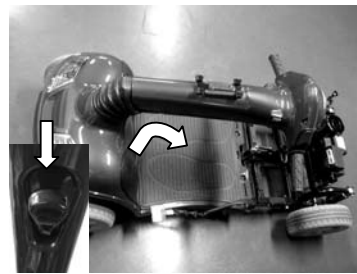

Brief instructions

7.) Unlock the drive unit

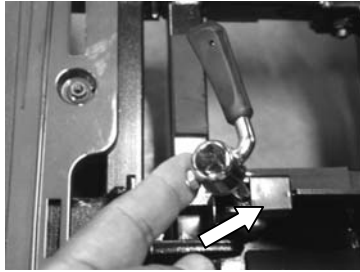

8.) Tilt the drive unit away

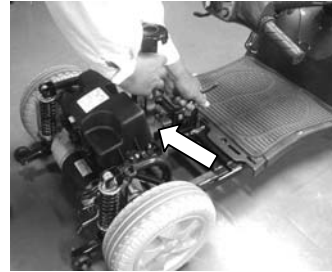

9.) Remove the chassis

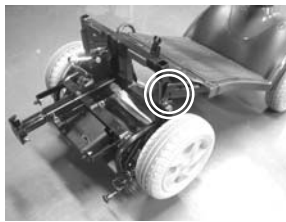

Step①

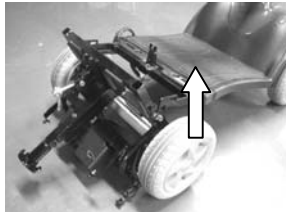

Step②



Step③

Reassembling the scooter
(Stages 9 to 1)

The scooter dismantled:

1. Chassis
2. Batteries
2. Drive unit
3. Rear panelling
4. Seat unit



Adjusting the seat height

6.0 Setting up the scooter

The following passage describes how to set up your scooter in order to ensure that you have a comfortable and safe drive.

6.1 Adjusting the seat height



NOTE!

The seat must be removed from the scooter in order to adjust the seat height. You should try to get help from a second person if possible or contact your dealer.

Removing the seat:

Tilt the backrest forwards.

Lift the seat while pulling the seat lock (a) out of the seat support (1).

Removing the seat

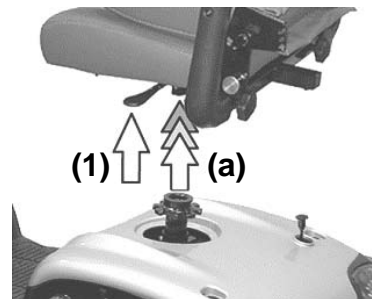

Adjusting the seat height:

Remove the clamping bolt (1) and hold bolt.(2) Out of the seat support (3).
1xRing spanner, size 12mm
1x Hexagon bolt.

Removing the clamping bolt and hold bolt

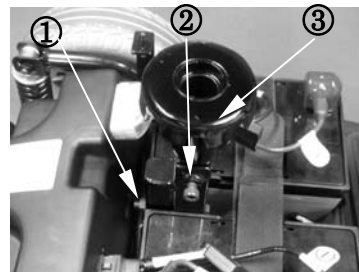

Adjusting the seat height



In order to avoid danger when driving. Please adjust the height of seat, and then confirm if the seat's bolt is at the right position, otherwise, the seat would be shaken.



The seat height (h) is adjusted using the five holes (1-4) in the seat support.

Pull the seat support (4) out as far as the required height until the correct hole (1-4) appears in the seat tube hole (5).

Push the clamping bolts (6) into the seat tube from the front.

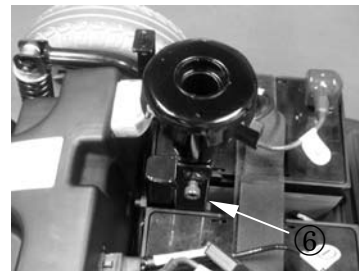
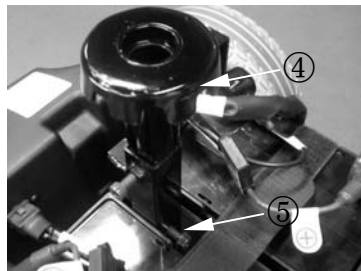

Adjusting the seat height

Inserting the seat:

Pull the seat lock (a) and guide the seat into the seat support (1) from above.

Let go off the seat lock and engage the rotational adjustment by turning the seat a little one way then the other.



NOTE

If after inserting the seat it is not possible to turn the seat or to pull the seatlock, the seat is not properly locked.

Inserting the seat

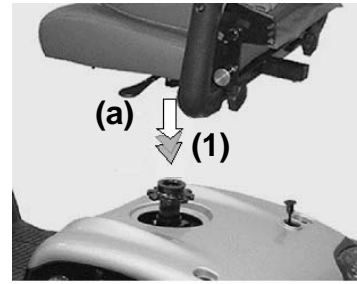

Adjusting the seat

6.2 Adjusting the seat position

6.2.1 Adjusting the distance between seat and tiller

Pull the locking lever (1) upwards and move the seat forwards or backwards to the required distance.

Let go of locking lever and engage the locking mechanism by pushing the seat slightly forwards and backwards.



Accident hazard due to non-engaged seat!

- Ensure that the seat is properly engaged after adjustment by pushing the seat slightly forwards and then backwards.

Moving the seat



6.2.2 Adjusting the armrest width

Loosen both clamping screws (2).

Pull both armrests (3) simultaneously to the required width.

Secure the armrests by tightening the clamping screws.

Adjusting the armrest width

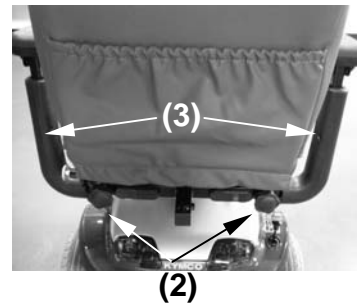

CAUTION!

- Do not pull the armrests further out than the marking (a) for maximum armrest width.

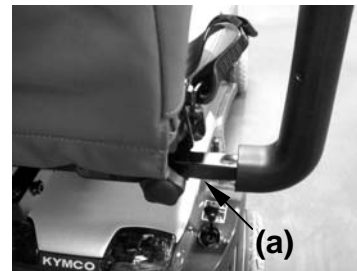

6.3 Adjusting the tiller angle

Always adjust the tiller so that you can reach all displays and controls easily at any time. The tiller can be variably adjusted.

Turn and loose the locking lever(1)

Pull the tiller for backwards into the required position .

Tighten the locking lever .

Ensure that the tiller is engaged properly by moving slightly forwards and backwards.



Accident hazard due to non-engaged tiller!

- Ensure that the tiller is properly engaged after adjustment by pushing it slightly forwards and then backwards.

adjusting the tiller

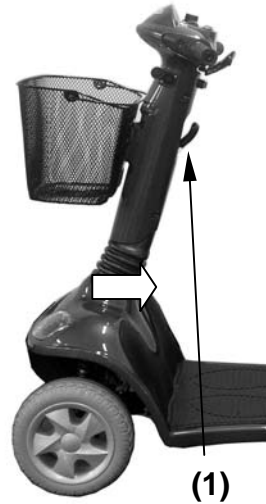

7.0 Information about safe driving



Always carry out the safety information described in chapter 1.4 “Safety when driving“!

Driving is very simple and after a few practice sessions you will find it very easy.

The following information should help you to drive safely through traffic:

- always match your speed to the driving situation in which you find yourself.
- always reduce the speed when you are driving through:
 - unclear areas
 - narrow gaps
 - tight curves
 - inclines
 - ramps
- take a trial run with your scooter in an area with no pedestrians, or in a closed-off area.
- always steer the scooter using both hands on the handlebars.
- always keep your feet in the foot area while driving .

Driving information

7.1 Driving up inclines and down slopes

The scooter will slow down to a safe reduced speed to protect the motor if in overload/ over heated conditions.

Please switch off and allow the motor to cool down before continuing your journey.

You may need to choose an alternative more suitable route if overload trip re-occurs.

Climb angle examples:

a 1 metre long ramp should not be higher than. 18 cm

a 2 metre long ramp should not be higher than. 36 cm

- Avoid driving across an incline (always try to drive in the direction of the incline / decline).

There is an increased **danger of tipping** when climbing or descending gradients if:

- the scooter is loaded at the back and additionally the seat has been adjusted to its rear position.



You can achieve increased **tipping safety** if:

- you adjust the seat in a more forward position.
- you lean your upper body slightly forwards (see sketch).



Driving information

7.2 Overcoming obstacles

The scooter can climb over obstacles such as kerbstones up to height of 8 cm without any problem.

Please observe the following points to make sure that your scooter doesn't tip over while climbing obstacles:

- don't try to drive over obstacles which are too high
example: kerbstones
remedy: always climb up kerbstones at lowered entry areas such as driveways.

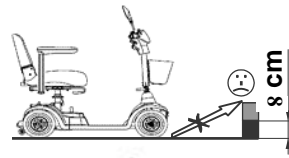
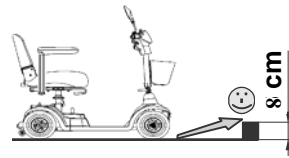

- **Do NOT** try to climb an obstacle when on an incline.

- approach the obstacle at a right angle
- try to clear the obstacle in one go.

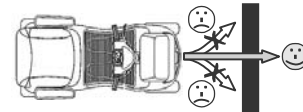

- **DO NOT** drive over the obstacle with just one wheel.

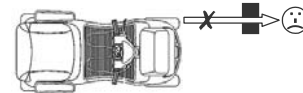

- **DO NOT** drive backwards over an obstacle.

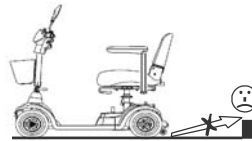

- **DO NOT** drive backwards down a kerb.

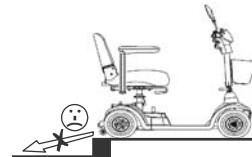

- **DO NOT** drive down stairs or steps.

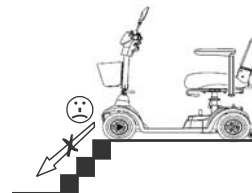

Driving information

7.2.1 Driving Information – Overcoming kerbs



Risk of accidents!

Neogating kerbs needs some practice.

- Please observe the maximum obstacle heights of **8 cm**.
- Please start practicing kerb climbing with small kerbs.

Approach the kerb at a right angle.

Approach at a right angle

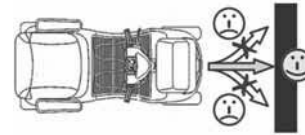

Stop approximately 0.5 Meter /
19 inches in front of the kerb.

Stop in front of the kerb

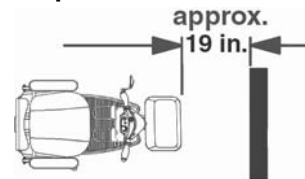

Adjust the speed- controller

Adjust the speed controller to maximum
speed.

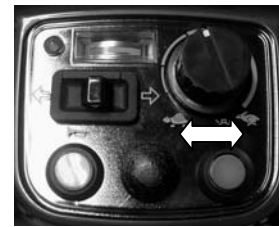

Press the drive lever fully forward and try
to clear the kerb in one go.
The speed of the scooter should only be
at 1 mph when the front wheels hit the
kerb.

Overcome kerb

Keep the drive lever in the fully forwards
position until the rear wheels have cleared
the kerb.



7.3 Overload protection - motor protection

The overload protection switches the drive off if the motor becomes overloaded by trying to climb over too high an obstacle such as a kerbstone, or if you try to climb too steep of an incline.

If the motor is overloaded, the following happens:

- the scooter becomes noticeably slower and then stops
- the control system switches the scooter off

To rectify this:

Switch the scooter off and allow it to cool down for a few minutes.

Switch the scooter on again and ...

... reverse away from the **obstacle** (such as kerbstone) and then try again at a lower point.

... be careful turning the scooter around on inclines, and always reverse away very slowly.



Tipping hazard!

There is an increased tipping hazard if the incline is very steep.

- Try to get help from a second person when turning your scooter around.



Accident hazard in push mode!

If the incline is too steep, there is a danger that you will not be able to hold onto the scooter and that it will roll down the incline uncontrolled.

- Try to get help from a second person when turning your scooter around.

7.4 Battery charging state = driving range

7.4.1 Battery charging state

Battery charge display

Battery charge display:

The battery charger display on the dashboard shows the battery charging state.



Full = maximum range

Medium = decreased driving range, charge batteries after journey

Reserve = minimum driving range, end journey as soon as possible, charge batteries

Display ranges

Red-reserve

Yellow-medium

Green-full

Important information about reading the battery charge display:

- If the scooter is at standstill, it is often the case that the battery charging state is shown higher than it actually is.
- The display can vary greatly while the vehicle is travelling (depending on load).
- If the vehicle is under heavier loading (for example heavy acceleration, driving up hills), the pointer can sometimes go to the red area of the display. This is not critical and does not indicate the actual charging state of the batteries.
- If the pointer has gone into the red area of the display after the journey, it will often show green after the scooter has been turned off for a long period.
This does not indicate the actual charging state of the batteries!
If the pointer is in the red area of the display at the end of the journey, the batteries must be charged before continuing the journey.
Disregarding this can lead to destruction of the batteries!

Determining the actual charging state:

Drive at a constant speed for about 200 m along a straight level route. The value shown by the display during the journey is the actual battery charging state.

7.4.2 Driving range

The driving range is dependent on the following conditions in addition to battery charge:

- landscape conditions (level or steep)
- weight of user
- weather conditions (cold, rain)
- driving with headlights (if fitted)

For this reason, information about the driving range is only given as a guideline. The more experienced you are in using scooter, the easier it will be for you to determine the driving range using the battery charging state.

You will be able to achieve the best possible driving range if you:

- ensure that the tyres are inflated correctly
- avoid steep inclines as much as possible
- do not carry any unnecessary luggage
- drive at an even speed
- do not accelerate or brake unnecessarily.

The driving range will be decreased if you:

- drive with headlights
- drive in cold weather
- drive in hilly regions



NOTE

please see the information about batteries in the Appendix.

7.4.3 Overdischarge protection - battery protection

In order to protect the batteries from over-discharging, the control unit switches off. This takes place when the battery voltage falls below 17 Volts.

Display:

the battery charger display pointer is pointing to the left at the end of the red area.

Battery charge display

To rectify this:

You must not drive any longer!

Connect the Scooter to the battery charger and charge the batteries for at least 12 hours.

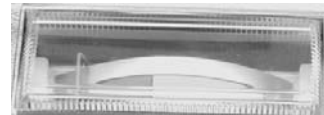

NOTE

If the battery voltage falls below 16 Volts, the batteries can no longer be charged with the battery charger supplied. In this case you must contact your dealer.

8.0 Driving

8.1 Getting on and off

Please observe the following before getting on or off:

- The scooter must be standing on firm, level and non-slippery ground.
- The engaging lever for push mode must be in the drive position (see chapt. 9.0)
- **Turn off** and remove the key.
- Tilt the steering column forwards (see chapt. 6.3)
- When getting in and out, ensure that your clothing does not get caught on the drive lever.



After you have got onto the scooter, pull the seat lock (1) forwards again, turn the seat to face the direction of travel (4) and engage.



Accident hazard due to non-engaged seat!

- Ensure that the seat is properly engaged after getting on by turning the seat slightly left and right.





NOTE!

If you feel you are safe enough, you can of course get onto the scooter without turning the seat round.

- You can lift up the armrest on the side where you are standing and then get on.



8.2 Turning the seat

The seat can be turned to both sides of the angle, and firmly engaged in 8 positions (each position turns 45°).

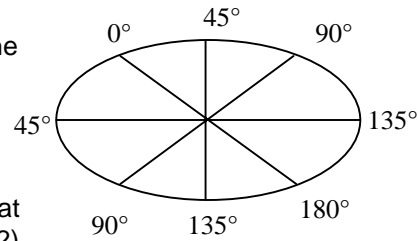

Turning the seat:

Pull the turning lock (1), turn the seat in the required direction or position (2) and engage.



Accident hazard due to incorrect seat position!

- Always turn the seat to face forwards and engage it before driving.

If the seat has been turned, the possibility of tipping is increased.

- Before turning the seat, always ensure that the scooter is on an even and solid surface.



Switching on

8.3 Switching on

The switch is located on the dashboard.

Insert the key into the switch and turn it to the right to switch on.



8.3.1 Operation indicator and fault display

This light shows that the scooter is switched on and ready for driving.

It also displays any errors in the scooter electronics and electrical system. Fault display takes place using different blinking speeds or blink sequences. You can find more information in the chapter entitled "Troubleshooting".

Operation indicator





8.4 Adjusting the speed

Your maximum driving speed can be variably adjusted using the speed controller.

Maximum driving speed = drive lever pressed as far as stop

Controller symbols:

 = lowest possible maximum driving speed (approx. 4mph)

 = highest possible maximum driving speed (approx. 6 mph)

Adjust the required maximum driving speed by turning the speed controller.

Speed controller



NOTE

Use the controller to adjust the speed to suit local conditions. Select a lower speed if you are driving through narrow gaps, on inclines or through crowds.

8.5 Before driving

Checks before driving:

- Are the batteries charged? Check the display! ✓ in working order!
- Are the brakes working? To check, drive slowly and stop again! ✓ in working order!
- Are the tyres and wheels undamaged and is the air pressure correct? Visual check of tyres and wheels! ✓ in working order!
- Is the tiller locking Observe chapter 13.3.4! ✓ in working order!



Only start driving if everything is in working order! Get defects repaired immediately.

8.6 Driving



Accident hazard due to locked tiller!

- Before driving off, turn the tiller to check that it is not locked. Observe chapter 13.3.4.

Hold the tiller firmly in both hands.

Press the drive lever (1) in the direction of travel until the required speed has been reached.

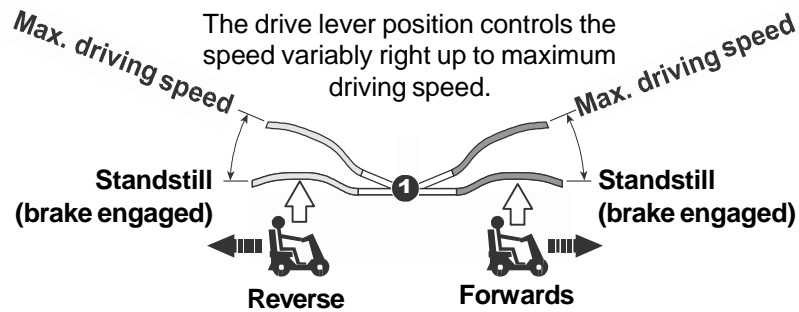
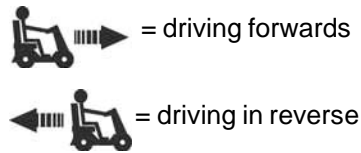

8.7 Using the motor brake

Let go of the drive lever (1).

The drive lever stops in the central position - the scooter uses the motor to brake.

Motor brake



Emergency braking = let go of the drive lever!

The drive lever automatically returns to the central position if you let go. The FOR U automatically brakes using the motor.

8.8 Using the horn

Press the horn button (5).

It will sound for as long as you hold the button down.

Using the horn



⑤

Switching off

8.9 Switching off / parking

Turn the key to the left to switch off.

Always turn off using the key switch if you:

- want to get on or off.
- intend to stop for long periods.

Always remove the key from the key switch if you:

- want to park and get off.



9.0 Pushing

In order to be able to push the scooter you must disengage the drive motor.
 The disengaging lever (1) is located on the right-hand side of the scooter.
 No one is permitted to sit on the scooter when it is being pushed.



Switch off.

Push the disengaging lever (1) forwards as far as the stop (limit position).

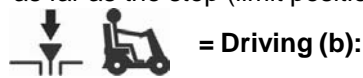

Pull the disengaging lever (1) to the rear as far as the stop (limit position).

Disengaging the drive

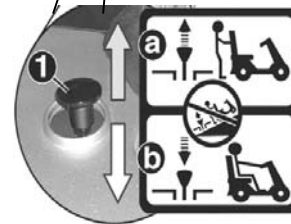
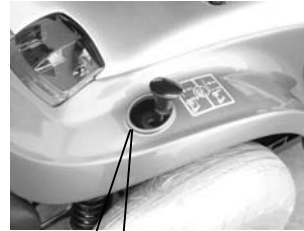

NOTES



- Always switch off to push it.
- If a pre-set speed is exceeded while you are pushing , the drive motor will switch on automatically and brake the scooter.



Risk of accidents!

- Do not pull the disengaging lever while driving.
- Never switch to push mode when somebody is sitting on the scooter.
- The engaging lever always needs to engage securely at the limit position.
- Do not disengage the motor when on an incline.

10.0 Attaching the shopping basket

Push the shopping basket (1) from above into the basket holder receptacles (2) on the tiller.



NOTE

Use the shopping basket only for small loading.

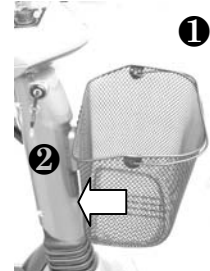

11.0 charging the batteries

Please also see the information given in the chapter entitled “Things to know”.

Charging information:

- The surrounding temperature should be between 10° and 30° Celsius. The charging time will increase at lower temperatures.
- Only use the original battery charger (included in delivery).
- Only use the battery charger in a dry and well-ventilated room.
- Do not cover the battery charger and ventilation slot while charging batteries.
- The battery charger has an automatic switch-off device which prevents overcharging the batteries. Do not leave the battery charger connected to the scooter for more than 24 hours.
 - The batteries can be charged overnight.
- Switch the scooter off before charging the batteries.

When is charging required?

- the battery charge display is in the red area
- after the final journey of the day
- at least once per week

Charging times:

Between 8 and 14 hours depending on current battery charge state.



NOTE

The battery charger is designed to be able to charge completely discharged batteries within eight hours to 80% of their capacity.

Charging the batteries

11.1 Charging the batteries

11.1.1 Charging the batteries via the tiller

Switch off.

Engage the engaging lever for push mode into the "drive" position.

It is imperative that you observe the sequence for connecting and disconnecting the battery charger.

The jack socket (3) for connecting the battery charger is located on the tiller.

Switching off



Engaging



Connecting the battery charger

- (1.) Connect the battery charger plug (4) to the charging socket.



- (2.) Connect the battery charger mains plug (5) to a mains socket and switch on.



NOTE:

The battery charger switches on automatically when connected to the mains.

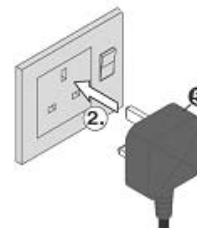

Charging the batteries

11.1.2 LED information at battery charger during charging

LED -> Colour -> Meaning

- (a) -> Red -> battery charger
 - > Orange -> charging in progress
 - > Green -> charging complete,

LED



11.2 After charging

- (1.) Switch off and remove the battery charger plug from the mains socket.

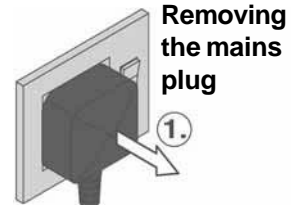

Removing the battery charger

- (2.) Pull the battery charger jackplug out of the jack socket.

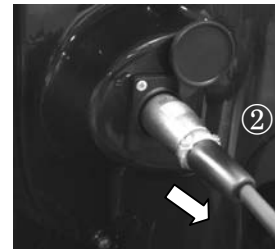

12.0 Things to know

12.1 The battery charger - functioning principle

The battery charger regulates the voltage (Volt) and the current (Ampere) from your mains connection down to the voltage required for charging your batteries (24 Volt). The amount of charging current required is dependent on the charging state of the discharged batteries.



Batteries mostly discharged = more charging current

Batteries half discharged = decreased charging current

Batteries completely charged = no charging current

Since no charging current is flowing when the batteries are full, the batteries cannot be overloaded.

12.2 The Batteries

The entire power supply is taken over by two 12 V batteries.

These are located below the motor cover under the seat.

The batteries used in the scooter are known as batteries for cyclic use.

Only enclosed maintenance-free batteries are used.

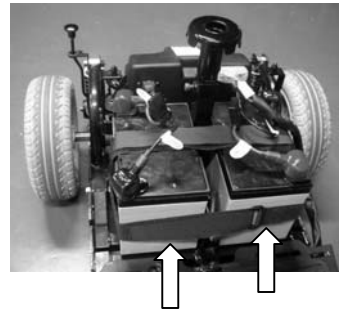

Things to know

12.2.1 What are batteries for cyclic use?

Batteries for cyclic use are designed, in contrast to starter batteries as used in cars, so that they deliver continuous energy over a longer period of time and allow a considerable number of charging phases.

12.2.2 When do the batteries achieve their maximum performance?

Fixed cycle batteries achieve a maximum performance after four or five charging and discharging cycles. Only at this point is their internal chemical equilibrium achieved so that they can produce maximum performance and service life.

12.2.3 How do I make sure the batteries achieve their best service life?

- Always charge your batteries completely after use.
- Charge your batteries regularly.
- Only store completely charged batteries in the vehicle.

Anti tipping wheels

12.3 Anti tipping wheels

The anti tipping wheels (1) reduce the danger of tipping during extreme manoeuvres when fixed to the rear of the scooter.

It is not permitted to drive the scooter without anti tipping wheels.



Wheels and tyres

12.4 Wheels and tyres

The Super 8 is fitted with 260 x85x4(solid tyres)



12.5 The drive unit

The complete drive unit is located in the rear of the scooter and consists of the following main components:

- the batteries(2)
- the drive motor with rear axle (3)
- the control unit (4)

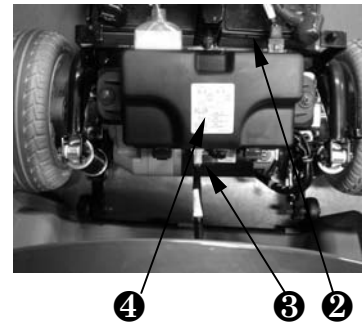

12.6 The working principle

The drive consists of the drive motor, the gearbox and the rear axle. Drive takes place from the drive motor via the gearbox and rear axle to the rear wheels .

12.7 The control unit

The control unit is a programmable electronic regulating unit. It regulates drive characteristics such as acceleration, maximum speed and braking behaviour. The drive characteristics can be set to match the user's requirements by altering the programming. Reprogramming may only be carried out by specialist dealers.

12.8 The auto switch-off

The auto switch-off automatically switches the scooter off after **10** minutes at a stand- still. This protects the batteries from being discharged if the ForU was inadvertently not switched off.

12.9 Brakes

The scooter is automatically braked if the drive lever (1) is in the central position. To apply the brakes, simply let go off the drive lever which is then returned to its central position by a spring. The scooter is then braked by the drive motor. When the scooter is at a standstill or has been switched off, it is braked by a magnetic brake.

Drive lever



12.10 Driver's licence

Not required!

12.11 Insurance

As a scooter user you must be aware of the risks involved to both yourself and others. It is recommended that you take out third party insurance to cover you against any possible claims. Advice and policies are available from insurance companies or alternatively ask your scooter supplier for details.

12.12 Approval for road traffic use

Super 8 ForU models are not defined as motor vehicles, but are a Class 2 Type invalid carriage. This type of scooter is for use on pavements and pedestrian areas with the exception of crossing roads.

Use on public roads only permissible when no pavement is available.

Transporting the scooter

13.0 Transporting the scooter

13.1 Transport information

Depending on the size of the transport vehicle, the scooter can be dismantled in a few steps so that it can also be easily transported in smaller vehicles.

When transporting, take particular care to ensure that the batteries are securely fastened and make sure components cannot tip over.

No liability can be accepted for damage caused by transportation.

13.2 Transporting the complete scooter



No persons are permitted to sit on the scooter during loading!

No persons are permitted to sit on the scooter during transport!

Drive or push the scooter up a ramp into the vehicle.

Switch the engaging lever to drive mode.

Secure the scooter against tipping over by fastening it to the transport vehicle with transport straps.

13.3 Preparation for transport - separating components



Clamping and crushing hazard!

Increased hazards due to clamping or crushing result due to the high component weight (such as batteries) during preparation for transport.

- Always carry out any work to be done with great care.
- Always try to get help from a second person, especially when stowing parts for transport.

Transporting the scooter

In just a few steps you can dismantle the scooter down to the following components to make it ready for transport:

1. Chassis
2. Batteries
3. Drive unit
4. Rear panelling
5. Seat unit



13.3.1 Working step summary

1. Remove the seat unit.
2. Remove the rear panelling.
3. Remove the batteries.
4. Fold the tiller down.
4. Disengage the drive unit from the chassis.

13.3.2 Removing the seat and rear panelling

Tilt the seat backrest forwards.

Lift the seat while pulling the seat lock (a) out of the seat support (1).

Pull the rear panelling (b) off the scooter upwards.

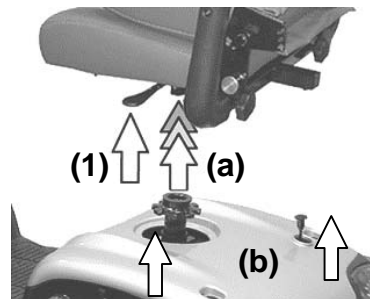

13.3.3 Removing the batteries

Press the locking device on the plug and disconnect connecting plugs on the cable.
Remove the battery belts.
Remove the batteries.

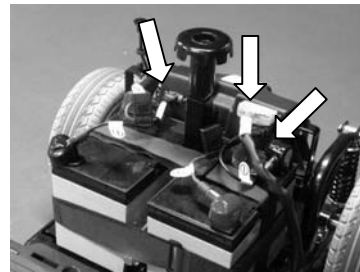

Transporting the scooter

13.3.4 Folding the tiller down

Pull the locking lever(1) and fold the tiller to the rear (2) until it is horizontal.

Folding the tiller down

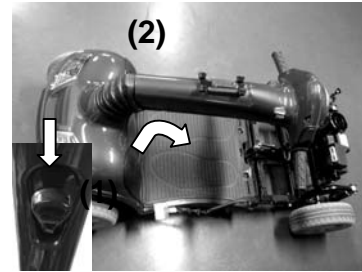

13.3.5 Disengaging the drive unit from the chassis

- (a) Separate the front unit connecting plug.
- (b) Open the clamping bolt clamping lever and fold the clamping bolt upwards.
- (c) Move the drive unit to the rear onto the anti tip wheels.
- (d) Remove the frames upwards from the holding bolts on the drive unit.

13.3.6 Installing step in the reverse order of removal.

14.0 Cleaning

**NOTE**

- Only use mild detergents without scouring agents to clean any surfaces.
- Please observe instructions for use on the detergents to avoid damage to the component surfaces.
- Do not use any sharp-edged tools such as knives, metal scrapers or aggressive solvents for cleaning.
- Do not use high-pressure cleaners to clean the scooters.
- Never direct water spray onto the fittings on the tiller or drive unit components.

Light soiling or dust is best removed using soft cloths.

Heavy soiling can best be removed with damp cloths and slightly soapy water.

Use a dry cloth to dry the scooter off after cleaning!

All lacquered surfaces can be cleaned and preserved using car polish.

15.0 Maintenance and Inspection

If you find any faults on your scooter during maintenance which are not covered by the repair information, please contact your dealer.

Always remove faulty scooters from operation and secure them against unauthorized use (remove key).

15.1 Daily maintenance before start of journey

Check the brakes by driving slowly and then braking.

Make a visual check of wheels and tyres for damage.

Maintenance and inspection

15.2 Annual inspection - inspection timetable

Take your scooter once per year to your dealer for an inspection. He will have the necessary tools and experience to service your scooter correctly.

Description (Component / inspection for)	Assessment		
	OK	Defective	
Component : Seat			
Seatbelt /	no damage	<input type="checkbox"/>	<input type="checkbox"/>
	fixed securely	<input type="checkbox"/>	<input type="checkbox"/>
	can be easily adjusted	<input type="checkbox"/>	<input type="checkbox"/>
	closed securely	<input type="checkbox"/>	<input type="checkbox"/>
Armrest padding /	no damage, fixed securely	<input type="checkbox"/>	<input type="checkbox"/>
Armrest, folding mechanism /	no play in joint	<input type="checkbox"/>	<input type="checkbox"/>
	functions easily	<input type="checkbox"/>	<input type="checkbox"/>
Armrests, width adjustment /	no damage	<input type="checkbox"/>	<input type="checkbox"/>
	functions easily	<input type="checkbox"/>	<input type="checkbox"/>
Backrest upholstery /	no damage	<input type="checkbox"/>	<input type="checkbox"/>
	fixed securely	<input type="checkbox"/>	<input type="checkbox"/>
Backrest adjustment /	no play in joint	<input type="checkbox"/>	<input type="checkbox"/>
	functions easily	<input type="checkbox"/>	<input type="checkbox"/>
Seat upholstery /	no damage	<input type="checkbox"/>	<input type="checkbox"/>
	fixed securely	<input type="checkbox"/>	<input type="checkbox"/>
Seat and back frames /	no damage	<input type="checkbox"/>	<input type="checkbox"/>
Seat support - chassis connection /	no damage,	<input type="checkbox"/>	<input type="checkbox"/>
	no play in connection	<input type="checkbox"/>	<input type="checkbox"/>

Maintenance and inspection

Description (Component / inspection for)	Assessment	
	OK	Defective
Component : Tiller	<input type="checkbox"/>	<input type="checkbox"/>
Panelling / no damage	<input type="checkbox"/>	<input type="checkbox"/>
fixed securely	<input type="checkbox"/>	<input type="checkbox"/>
Grip rubbers / no damage	<input type="checkbox"/>	<input type="checkbox"/>
fixed securely	<input type="checkbox"/>	<input type="checkbox"/>
Tiller, folding mechanism / no play in joint	<input type="checkbox"/>	<input type="checkbox"/>
functions easily	<input type="checkbox"/>	<input type="checkbox"/>
Component : chassis		
Connections / no damage	<input type="checkbox"/>	<input type="checkbox"/>
Frames / no damage	<input type="checkbox"/>	<input type="checkbox"/>
no corrosion	<input type="checkbox"/>	<input type="checkbox"/>
Reflectors / no damage	<input type="checkbox"/>	<input type="checkbox"/>
Steering mechanism / no damage	<input type="checkbox"/>	<input type="checkbox"/>
no play in joint	<input type="checkbox"/>	<input type="checkbox"/>
functions easily	<input type="checkbox"/>	<input type="checkbox"/>
Wheels / no damage	<input type="checkbox"/>	<input type="checkbox"/>
fixed securely	<input type="checkbox"/>	<input type="checkbox"/>
Tyres / no damage	<input type="checkbox"/>	<input type="checkbox"/>
Antitipper wheels / no damage	<input type="checkbox"/>	<input type="checkbox"/>
rollers turn easily	<input type="checkbox"/>	<input type="checkbox"/>

Maintenance and inspection

Description (Component / inspection for)	Assessment	
	OK	Defective
Component : Displays and controls, electric system, electronic system		
Drive lever/ No damage	<input type="checkbox"/>	<input type="checkbox"/>
Easy functioning over the entire lever movement	<input type="checkbox"/>	<input type="checkbox"/>
Returns to central position after releasing from any position	<input type="checkbox"/>	<input type="checkbox"/>
Secure blockage of magnetic brakes when lever is in central position (scooter can not be pushed)	<input type="checkbox"/>	<input type="checkbox"/>
Dashboard switches / no damage	<input type="checkbox"/>	<input type="checkbox"/>
safe function	<input type="checkbox"/>	<input type="checkbox"/>
Dashboard displays / no damage	<input type="checkbox"/>	<input type="checkbox"/>
safe function	<input type="checkbox"/>	<input type="checkbox"/>
Indicator lamps / no damage	<input type="checkbox"/>	<input type="checkbox"/>
safe function	<input type="checkbox"/>	<input type="checkbox"/>
Charger jack socket / no damage	<input type="checkbox"/>	<input type="checkbox"/>
Batteries / no damage	<input type="checkbox"/>	<input type="checkbox"/>
fixed securely	<input type="checkbox"/>	<input type="checkbox"/>
Check battery voltage (12-14 Volt per battery)	<input type="checkbox"/>	<input type="checkbox"/>
Check battery capacity		
Control unit / no damage	<input type="checkbox"/>	<input type="checkbox"/>
fixed securely	<input type="checkbox"/>	<input type="checkbox"/>
Cables and connecting plugs / no damage	<input type="checkbox"/>	<input type="checkbox"/>
fixed securely	<input type="checkbox"/>	<input type="checkbox"/>

Maintenance and inspection

Description (Component / inspection for)	Assessment		
	OK	Defective	
Component : Drive			
Motor, drive /	no damage	<input type="checkbox"/>	<input type="checkbox"/>
	fixed securely	<input type="checkbox"/>	<input type="checkbox"/>
	drive noise	<input type="checkbox"/>	<input type="checkbox"/>
Motor, magnetic brake / holding force OK (Scooter can not be pushed with engaging lever in drive-position)	<input type="checkbox"/>	<input type="checkbox"/>	
Engaging lever /	no damage	<input type="checkbox"/>	<input type="checkbox"/>
	functions easily	<input type="checkbox"/>	<input type="checkbox"/>
	lever engaged	<input type="checkbox"/>	<input type="checkbox"/>
	(lever remains engaged)	<input type="checkbox"/>	<input type="checkbox"/>

16.0 Troubleshooting

16.1 Before troubleshooting

Before you start troubleshooting, please observe the following points to avoid simple error sources.

Switch off.

Ensure that the main plug (1) and the battery plug(2) for a tight fit.

Switch on again.

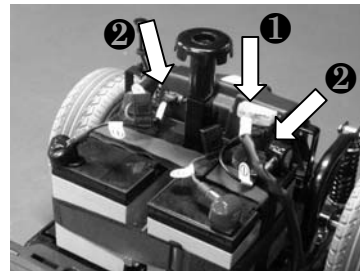

If the error should occur again, you can find information about troubleshooting and appropriate remedies in the lists in sections 16.2 and 16.3.

Troubleshooting

16.2 Troubleshooting

Fault	Cause	Remedy
Scooter does not run / no display at the dashboard	Scooter not switched on	Switch the scooter on (chapter 8)
	Power supply interrupted	Battery not plugged in
		Front unit connector not plugged in
		Check the battery fuses (chapter 17)
		Check fuse in power supply to tiller head (chapter 17)
	Batteries discharged	Charge the batteries (chapter 10)
Batteries defective	Replace (dealer)	
Scooter does not run	Check battery charge display (battery discharged).	Charge the batteries (chapter 10)
	switched to push mode	Switch to drive mode (chapter 9)
	Drive lever pressed while switching on	Release
	Fault on drive lever	Visit your dealer
	Automatic switch-off (overload off protection) active	Switch scooter off and switch scooter on again a few seconds later for the unit to reset.
	Operation indicator blinking	Check blink code (chapter 16)

Troubleshooting

Fault	Cause	Remedy
Main fuses blow frequently	Batteries defective	Visit your dealer
	Motor defective	
	Fault in control unit	
	Short-circuit in electrical equipment	
Battery charge display moves rapidly to discharged during journey	Batteries discharged	Charge the batteries (chapter 10)
Motor jerks during driving	Batteries defective	Visit your dealer
	Motor defective	
Batteries do not charge	Defective fuse in power supply to tiller head	Visit your dealer
	Defective fuse in battery cable	Visit your dealer
	Front unit connector not plugged in	Plug in front unit connector (chapter 13)
	Battery charger defective	Visit your dealer
	Batteries completely discharged	

Troubleshooting

16.3 Operation indicator blink codes

The operation indicator (1) on the dashboard is also designed as a display for error messages.

Various faults in the drive electronics are displayed using blink sequence is as listed.

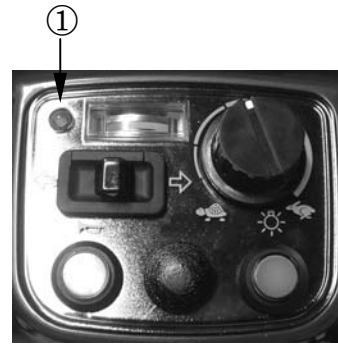

16.3.1 Blink list

Instrument indicator

Error code	LED indicator	Cause
	slight blink	Auto switch off(scooter stay 10min) · KEY-ON again
002,003	8xblink	Fault in ECU or wires fall off
0203,0204	8xblink	Fault in ECU or wires fall off
0810 0814~17	7xblink	Fault in drive lever, Lever does not reset
1000	blinking quickly	Charging the scooter, scooter does not run
1400	3xblink	Fault to motor brake or wires fall off
1500 ~1502	9xblink	Fault to motor brake
1600	10xblink	Battery voltage too low
1705	8xblink	Fault in ECU or wires fall off
1802 1805	8xblink	Fault in ECU or wires fall off
1B20	8xblink	Fault in ECU or wires fall off
1D02	7xblink	Fault in drive lever, Lever does not reset
1E03	6xblink	Charging the scooter, scooter does not run
2102	8xblink	Fault in ECU or wires fall off
2C00,2C01	1xblink contiute slowly	Batteries voltage too low
2D01	8xblink	Fault in ECU or wires fall off
3100 3102	8xblink	Fault in ECU or wires fall off
3210 3213	8xblink	Fault in ECU or wires fall off
3600~360E	8xblink	Fault in ECU or wires fall off
3B01	2xblink	Motor cable short-circuited
4401	8xblink	wires fall off
7000~7001	4xblink	Parking brake off

17.0 Repairs

The following repair information should enable you to carry out small repairs on your vehicle yourself. You should, however, only carry out such work if you are used to working with the tools described here since it is impossible to fully prevent injury hazards when handling tools. If you are not sure, you should try to get help from a second person if possible or contact your dealer.

In order to guarantee that all nuts and fixing screws are fitted tightly after repairs, you should ensure that these are tightened using the torque specified.

17.1 Information about safety at work



Clamping and crushing hazard!

Pay particular attention to hazards caused by clamping and crushing while carrying out any repair work. This applies particularly to all rotating and adjustable parts of the scooter such as around the steering wheels.

The scooter must be lifted in order to carry out certain work such as removing the wheels.

Before you lift the scooter, make sure you prevent it rolling away by wedging it securely.

Make sure the vehicle cannot fall down when raised by using suitable supports such as wooden blocks.

Always place the blocks under metal components such as frames, drive units.

Do not support the scooter by the plastic panelling!

17.2 Tools

The following tools are necessary to carry out the repairs described:

- 1 x screwdriver; Phillips head No. 2
- 1 x screwdriver
- 1 x ring spanner, size 10mm
- 1 x ring spanner; size 12 mm
- 1 x ring spanner; size 14 mm
- 1 x ring spanner; size 17 mm
- 1 x socket spanner, size 19 mm

17.3 Wheels - removal and replacement

Tools required:

Front wheel: 1 x socket spanner, size 17 mm

Rear wheel: 1 x socket spanner, size 19mm

Removing the wheels:

Unscrew the valve cap(1)

Loosen the self-locking bolt (2) for the wheel fastening.

Secure against rolling away.

Lift the scooter and support it

Remove the self-locking bolt for the wheel fastening.

Pull the wheel off the stem.



NOTE

Do not use force to remove the wheels from the axles.

Your specialist dealer has the necessary special tools.

Front wheel

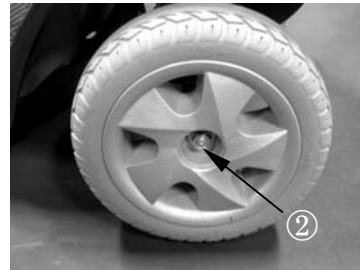

Rear wheel



Fitting the front wheel:

Push the wheel onto the stem (3) as far as the wheel stop.

Fitting the front wheel

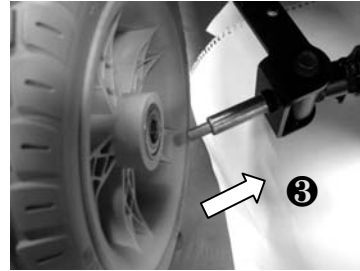

Screw the wheel fixing self-locking bolt (4) and tighten it (size 17 mm).

Lower the scooter.

Retighten the self-locking bolt (4).

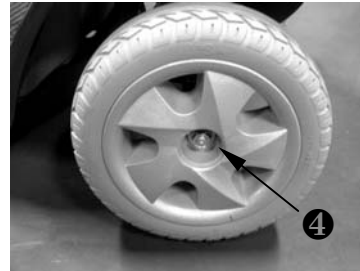

Fitting the rear wheel:

Place the key (5) in the slot in the drive shaft (6).



NOTE

The key is rectangular. Place it with its widest side in the axle slot.

Locating the axle key

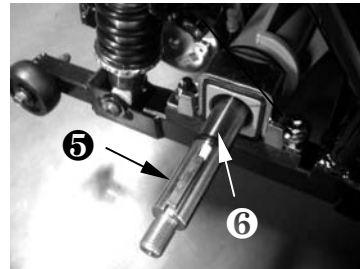

Push the wheel onto the stem and align the wheel hub groove (7) with the key in the drive shaft.

Push the wheel on as far as the drive shaft stop.

Fitting the rear wheel

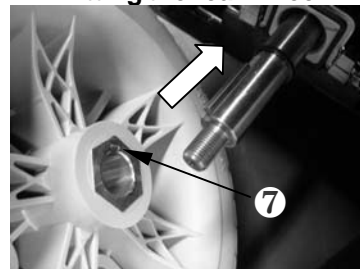

Repairs

Locating the washer

Place the washer (8).

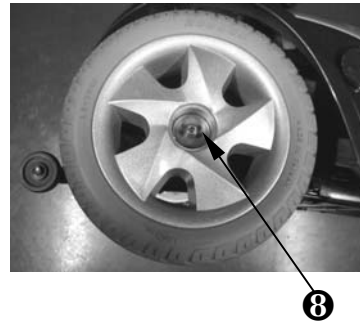

Securing the rear wheel

Screw the wheel fixing self-locking bolt (9) and tighten it (size 19mm).

Lower the scooter.

Retighten the self-locking bolt.

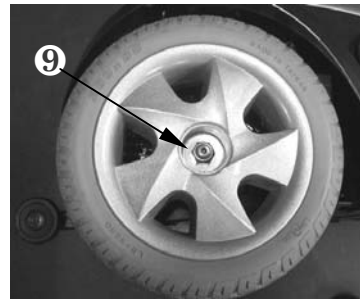

17.4 Replacing the wheel

Remove the damaged wheel.
(wheel with tyre is one set)

The wheel to be replaced
with a new set

Front wheel



Rear wheel



Repairs - fuses

17.5 Fuses

Wiring diagram

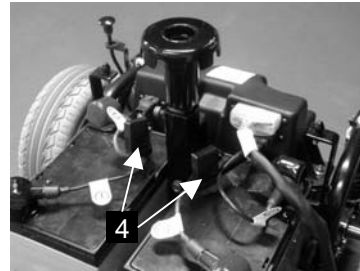
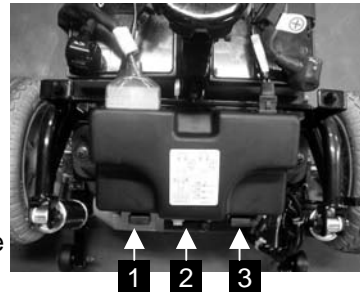
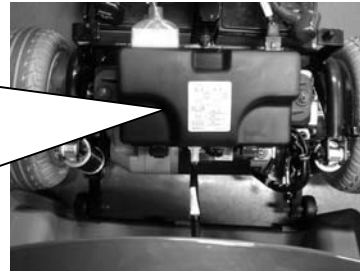
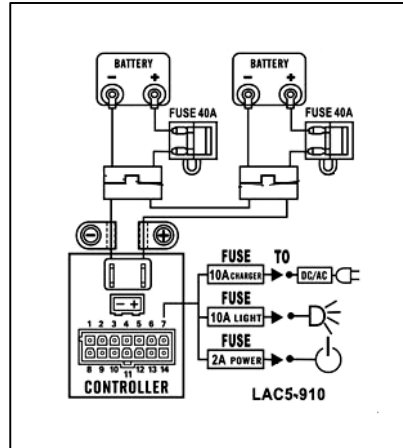

A wiring diagram with fuse sizes is located on the control unit cover.
The scooter is fitted with the following fusible fuses.
The fuses are located back the control unit cover.

- (1) 2A fuse= power supply to tiller.
- (2) 10A fuse= light.
- (3) 10A fuse= charging socket.
- (4) 40A fuse= in each battery positive cable

To replace Fuse:

- (A) Open fuse holder.
- (B) Pull out fuse and replace it.
- (C) Close fuse holder.



17.6 Batteries

Only replace the batteries with the following battery types:

12 V / 22 Ah, lead acid deep cycle batteries.

You may **not** use wet cell batteries with detachable cover caps.



Risk of accidents!

- Refitting the battery may only be carried out by your dealer.

17.7.1 Disposal of used or damaged batteries



Caution acid!

- Observe safety information in chapter 1



BATTERIES ARE HAZARDOUS WASTE!!

Used and defective batteries must be properly disposed of and only handed over to the correct disposal points.

Please give used or damaged batteries back to your dealer.
He will ensure that they are properly disposed of.

Handling damaged batteries:

When handling damaged batteries or objects which have been soiled with acid, you must always wear:

- protective goggles
- acid-proof gloves
- respiratory protection

Always wash soiled objects and tools with plenty of water.

Transporting damaged batteries:

Always wear protective goggles and acid-proof gloves.

Always transport and store batteries in an acid-proof container.

17.7.2 Refitting battery cables



Fire and burn hazard if battery terminal is short-circuited!

- Never touch both battery terminals simultaneously with tools (shorting out).
- Terminals are protected with insulating caps. Only ever remove the insulating cap from the terminal which you are going to loosen.

Tools required:

2 x ring spanner; size 10 mm

Remove the batteries from the scooter .

Refitting the battery cable:

First (1) loosen the terminal on the battery negative terminal (black cable) and remove the cable.

Then (2) loosen the terminal on the battery positive terminal (red cable) and remove the cable.

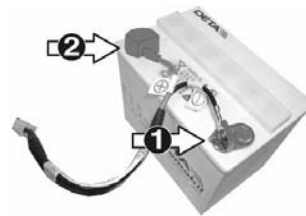

Replacing the battery and connect the battery cable in reverse order:

First connect the cable to the battery **positive terminal (2)**.

Then connect the cable to the battery **negative terminal (1)**.

Reinserting the batteries into the scooter

Temporary storage

18.0 Temporary storage

If you are not intending to use your scooter for longer periods (e.g. over the winter, you should prepare it as follows:

Remove soiling and dust.

Charge the batteries completely.

Place the scooter on supports. Lift high enough so that the tyres are no longer touching the floor.

Front support



Care during storage:

Recharge the batteries once a month (see chapter 10).

Rear support



Appendix - specifications

19.1 Specifications

19.1.1 General data

Version	Super 8 ForU
Turning radius	1560 mm
Speed	9.6 kph (6 mph)
Maximum range*	approx. 35km(21miles)
Maximum climable incline	10°
Maximum climable obstacle	80 mm
Total weight (ready for driving incl. Batteries)....	90 kg
weight heaviest part	26.1 kg
Maximum working load (user weight)	160 kg (350lb)
Tyre size	260/85 – 4 (solid tyres)
Working voltage (battery voltage)	24 Volt
Batteries	12V36AHX2
Main fuse	1 x 40 A
Storage temperature	- 40°C to + 65°C
Ambient temperature	- 25°C to + 50°C
Bulbs:	
Position light	24 Volt / 5 Watt
Rear position light	12 Volt / 5 Watt
Front indicator	24 Volt / 10 Watt
Rear indicator	24 Volt / 10 Watt

Appendix - tightening torques

19.2 Torque for fixing screws

Front wheel central self-locking bolt = 50 Nm

Rear wheel central self-locking bolt = 60 Nm

General torque for nuts and bolts:

M5 = 4.5 to 6 Nm

M6 = 8 to 12 Nm

M8 = 18 to 25 Nm

M10 = 30 to 40 Nm

M12 = 50 to 60 Nm

19.3 Disposing of the scooter

The scooter consists of metal and plastic components, electronic components, electrical cables and batteries.

Disposal of the individual materials must be carried out in accordance with environmental and disposal regulations in the relevant country, and may only take place after the scooter has been dismantled.

To dismantle the electromobile and to separate and dispose of the materials, you would be advised to hand it over to your specialist dealer.

Batteries may not be disposed of in domestic waste, and must be disposed of according to national regulations

20.0 Warranty information

The Super 8 ForU Model scooters are warranted for 12 months from date of purchase.

Important!

- During the warranty period any parts that have become defective due to faulty workmanship or material will be repaired or replaced without charge by KYMCO HEALTHCARE supplier / dealer.
- The warranty excludes tyres and all items that have been subject to undue wear and items subjected to misuse.
- Unauthorized changes or modifications will forfeit your warranty.
- If a defect or fault is discovered, **KYMCO Healthcare** supplier / dealer from whom the scooter was purchased should be notified immediately.

Limitation of liability

The warranty does not extend to the consequential costs resulting from fault clearance, in particular freight and travel costs, loss of earnings, expenses, etc.

The manufacturer will not accept responsibility for any damage or injury caused by misuse or non-observance of the instructions set out in this user manual.

Work Shop use only-- Replacing the ECU(1)

ECU Version:

The control unit is a programmable electronic regulating unit. It regulates drive characteristics such as acceleration, maximum speed and braking behavior.

The drive characteristics can be set to match the user's requirements by altering the programming.

Reprogramming may only be carried out by specialist dealers.

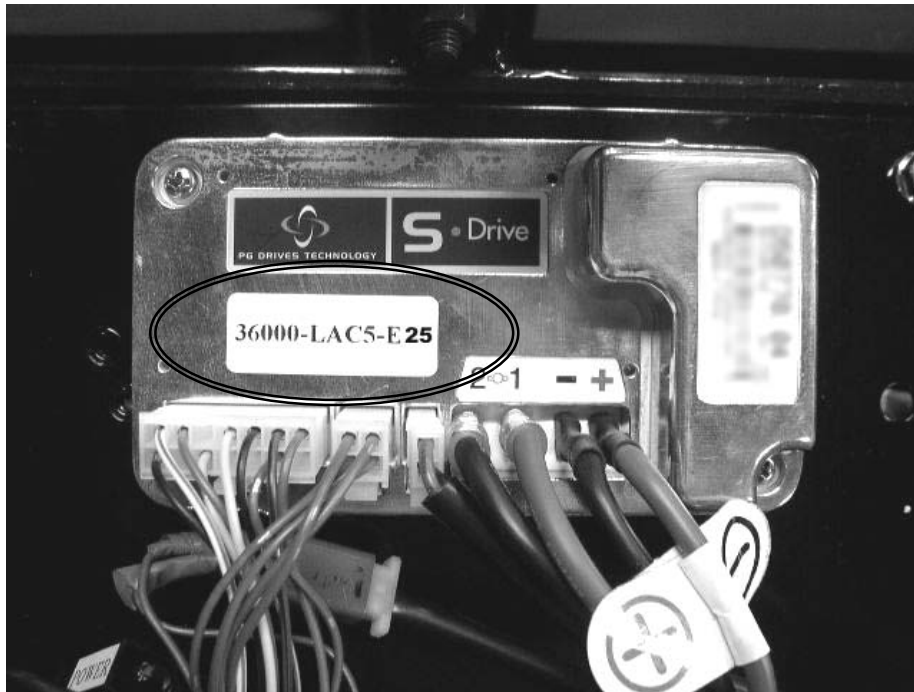

Work Shop use only-- Replacing the ECU(2)

- Switch the Scooter off.
- Remove the seat unit.
- Removing the rear panelling.
- Remove the lighting cable.
- Remove ECU protect cover bolts and battery plug and front connector.
- Disassemble the battery plugs (+)(-)and (1)(2) as picture--①
- Disassemble the ECU's plug as picture--②
- Remove ECU bolts --③.
- Disassemble the ECU--④.
- Installation is in the reverse order of removal.
- Attached to wire diagram.



Work Shop use only-- Removing and installing the motor

- Switch the Scooter off.
- Remove the seat unit.
- Removing the rear panelling.
- Remove the lighting cable.
- Remove ECU protect cover bolts and battery plug and front connector.
- Disassemble the battery plugs (1)(2) as picture--①
- Disassemble the ECU's plug as picture--①
- Remove the rear wheels.
- Remove the motor stay bolts as picture.--②
- Disassemble the electric motor.

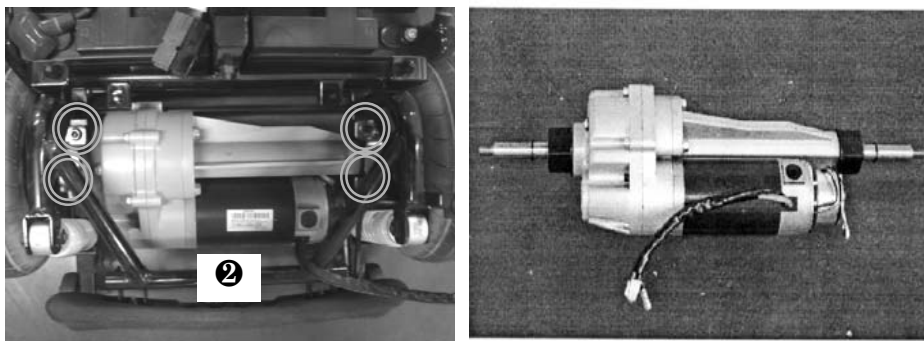
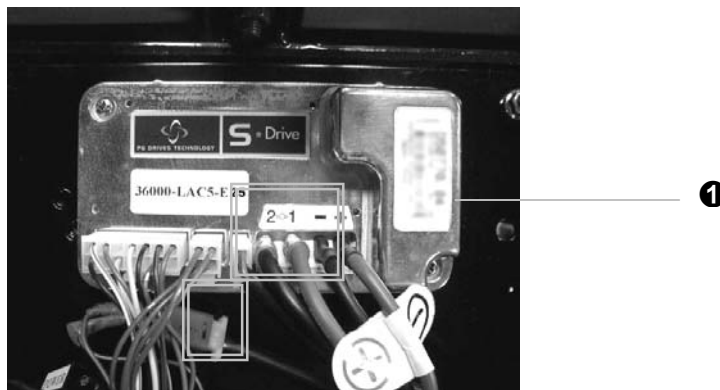

Step 1: Handlebar

- Push the tiller backward into the required position.
- Moving the handlebar to the seat as picture
- Ensure the handlebar is fixed firmly by seat. If the throttle levers touch the seat, remove the throttle levers.

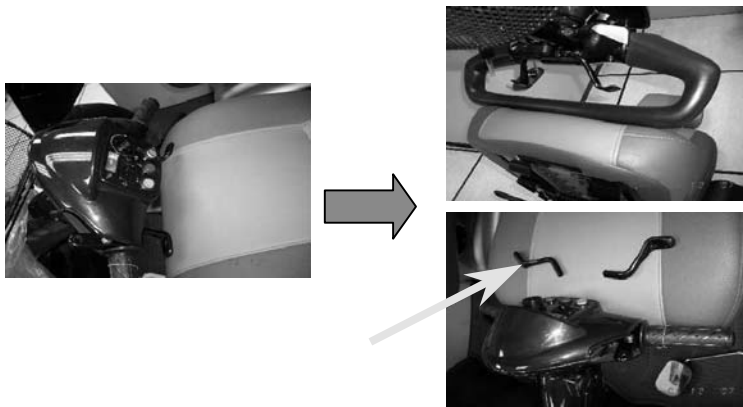

Work Shop use only-Adjusting the TOE-IN(2)

Step 2: Measure the tyre's "toe-in"

Separately measure the figure between the upper and lower side.

For Midi XL, should setting the standard point as picture.



Lower



Upper



Standard point



Step 3: Adjusting the longer rod's figure

- For tyre's "toe-in", the upper distance should be less than the lower one.

Standard: Maxi 0~5 mm
Midi XL& Midi Super 4/8 0~4 mm
Mini & Micro 0~3 mm
To tighten the rod's nuts after adjusting



Correct



Wrong

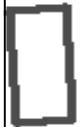

Forward



Work Shop use only-Adjusting the TOE-IN(3)

Step 4 : Adjusting the shorter rod's figure

- To straighten the front tyres
- The steering stem should be centered the body frame by adjusting the shorter rod
- The front tyre parallels the steering stem by sight.
- Tighten the shorter rod's nut after adjusting.

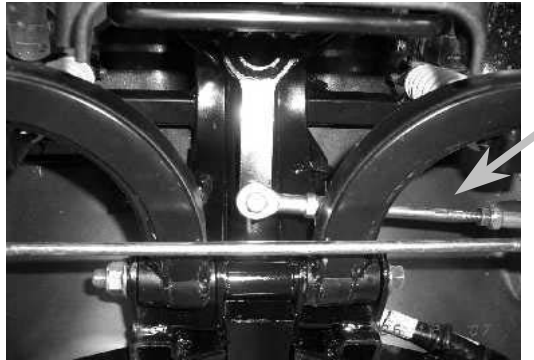

Work Shop use only- SP1 (Diagnostic Tool) introduction(1)

Menus:

You are in a menu if the display shows a message ending with " ? "



Use the up and down keys to look through the menu.



Use the help key to find out what each menu item does



Press the enter key to use a menu item

Once you are inside a menu item

Use the help key to find out what to do next



Trying out your setting

You can drive at any time



Work Shop use only- SP1 (Diagnostic Tool) introduction(2)

Using your SP1:

Remove the seat unit.

Pull the rear panelling off the scooter upwards.

Remove diagnosis tool connector protect plug.

Plug in the SP1.--①

Switch on the controller.

The SP1 is ready for use.

When you finish:

Unplug the SP1.

The controller is ready to drive.



Work Shop use only-Controller work sheet

<i>P&G SDRIVE 24 Volt 90Amp</i> CONTROLLER WORKSHEET			PARAMETER NO. : 36010-LDB4-E500-UK ECU : 36000-LDB4-E500-UK EQ35CB(UK)		
CONTROLLER PARAMETERS	DESIRED SETTINGS		RANGE	UNITS	DESCRIPTION
	FAST	SLOW			
FORWARD ACCELERATION	15	15	0.1 TO 10S FAST / SLOW		
FORWARD DECELERATION	3	6	0.1 TO 10S FAST / SLOW		
REVERSE ACCELERATION	25	25	0.1 TO 10S FAST / SLOW		
REVERSE DECELERATION	8	10	0.1 TO 10S FAST / SLOW		
FORWARD SPEED(MAX.)	100	45	0 TO 100% FAST / SLOW		
FORWARD SPEED(MIN.)	50	25	0 TO 100% FAST / SLOW		
REVERSE SPEED(MAX.)	35	25	0 TO 100% FAST / SLOW		
REVERSE SPEED(MIN.)	21	21	0 TO 100% FAST / SLOW		
THROTTLE INVERT	NO		NOYES		See page 35
SLEEP TIMER	10		0 TO 20 MINUTES		

NOTE:

***Specifications are subject to change without notice.**

By KWANG YANG Motor Co., Ltd.
First Edition, Jan. 2011
All rights reserved. Any reproduction or
unauthorized use without the written permission of
KWANG YANG Motor Co., Ltd.
is strictly prohibited.
T300-EQ35CB -A1



- NO.35 Wan Hsing Street, San Min District Kaohsiung city, **Taiwan**, Republic Of China
- NO.61, Chung-Shan Sth Rd , Lu-Chu Village , Kaohsiung County, **Taiwan**, Republic Of China

Date printed: Jan. 2011



KYMCO Healthcare UK Limited

Heol Mostyn

Village Farm Industrial Estate

Pyle

Bridgend

CF33 6BJ

TEL:01656 670095 FAX:01656 858353

www.kymcohealthcare.co.uk



KWANG YANG MOTOR CO., LTD

No.35 Wan Hsing Street, San Min Distrist

Kaohsiung **Taiwan**, Republic of China

Telephone:886-7-3822526

FAX : 886-7-3950021

