

Invacare® Pegasus Series

Pegasus^{METRO}, Pegasus^{PRO}

en Scooter
User Manual



This manual **MUST** be given to the user of the product.
BEFORE using this product, read this manual and save for future reference.



Yes, you can.®

©2017 Invacare® Corporation

All rights reserved. Reproduction, duplication or modification in whole or in part is prohibited without prior written permission from Invacare. Trademarks are identified by ™ and ®. All trademarks are owned by or licensed to Invacare Corporation or its subsidiaries unless otherwise noted.

Invacare® reserves the right to alter product specifications without further notice.

Contents

1 General	5
1.1 Introduction	5
1.2 Symbols in this manual	5
1.3 Type classification	6
1.4 Intended use	6
1.5 Regulations	6
1.6 Warranty	6
1.7 Service life	6
1.8 Limitation of liability	6
2 Safety	7
2.1 General safety notes	7
2.2 Safety information on the electrical system	9
2.3 Safety information on electromagnetic interference	10
2.4 Safety information on driving and freewheel mode	11
2.5 Safety information with regard to care and maintenance	13
2.6 Safety information regarding changes and modifications to the mobility device	14
2.7 Labels on the product	16
3 Components	19
3.1 Main parts of the scooter	19
3.2 Operating console (LED version)	19
3.3 Operating console (LCD version)	21
4 Setup	23
4.1 General setup information	23
4.2 Moving the seat position forwards or backwards	24
4.3 Adjusting the armrest width	24
4.4 Adjusting the armrest height	25
4.5 Adjusting the armrest angle	25
4.6 Adjusting backrest angle	26
4.7 Adjusting the headrest	26
4.8 Disengaging the seat to rotate or remove it	27

4.9 Adjusting the angle of the steering column	27
5 Accessories	29
5.1 Posture belts	29
5.1.1 Types of posture belts	29
5.1.2 Adjusting the posture belt correctly	29
5.1.3 Installing the posture belt	30
5.2 Rollator bracket	30
5.2.1 Attaching the rollator	31
5.2.2 Removing the rollator bracket	32
5.2.3 Positioning the rear reflector	32
5.3 Changing the colored shrouds	32
6 Usage	34
6.1 Getting in and out	34
6.2 Before driving for the first time	35
6.3 Taking Obstacles	35
6.3.1 Maximum obstacle height	35
6.3.2 Safety information when ascending obstacles	35
6.3.3 The correct way to overcome obstacles	35
6.4 Driving up and down gradients	36
6.5 Parking and stationary	36
6.6 Use on public roads	36
6.7 Pushing the scooter by hand	36
6.7.1 Disengaging motors	37
6.8 Driving the scooter	37
6.9 Switching the lights on and off	38
6.10 Switching the direction indicator on and off	38
6.11 Switching the hazard lights on and off	38
6.12 Using the horn	38
6.13 Switching the low speed mode on and off	39
6.14 Activating and deactivating curve control during bend travel	39
6.15 Mode selection	39
6.16 Adjusting the display	40
7 Controls system	44
7.1 Controls protection system	44

7.1.1	The main fuse	44
7.2	Batteries	44
7.2.1	General information on charging	44
7.2.2	General instructions on charging	44
7.2.3	How to charge the batteries.	45
7.2.4	How to disconnect the batteries after charging.	46
7.2.5	Storage and Maintenance.	46
7.2.6	Instructions on using the batteries	46
7.2.7	Transporting batteries	47
7.2.8	General instructions on handling the batteries	47
7.2.9	Removing the batteries	47
7.2.10	How to handle damaged batteries correctly	48
8	Transport	49
8.1	Transport - General information.	49
8.2	Transferring the mobility device to a vehicle	49
8.3	Transporting the mobility device without occupant	50
9	Maintenance	51
9.1	Maintenance introduction	51
9.2	Cleaning the mobility device	51
9.3	Inspection checks	51
9.4	Wheels and tires.	52
9.5	Long-term storage.	53
10	After Use	55
10.1	Reconditioning	55
10.2	Disposal	55
11	Troubleshooting	56
11.1	Diagnosis and fault repair	56
11.1.1	Error diagnosis.	56
11.1.2	Error codes and diagnostic codes	57
12	Technical data	59
12.1	Technical specifications	59
13	Service.	65
13.1	Inspections performed.	65

1 General

1.1 Introduction

Thank you for choosing an Invacare product.

This user manual contains important information about the handling of the product. In order to ensure safety when using the product, read the user manual carefully and follow the safety instructions.

Before reading this manual, make sure you have the latest version. You find the latest version as a pdf on the Invacare website (see back page of this manual). If you find that the font size in the print version of the user manual is difficult to read, you can download the pdf from the website. The pdf can then be scaled on screen to a font size that is more comfortable for you.

This mobility device has been constructed for a large circle of users with different requirements.

The decision whether the model is suitable for the user may only be taken by medical specialists with appropriate expertise.

Some maintenance and settings can be performed by the user or his/hers attendants. Certain adjustments do however require technical training and may only be carried out by your Invacare specialist provider. Refer to the Inspection checks chapter in 9 Maintenance, page 51. Damages and errors caused by nonobservance of the user manual or as a result of incorrect maintenance are excluded from all guarantees.

For more information about the product, for example product safety notices and product recalls, contact your local Invacare representative. For address and website see back page of this manual.

1.2 Symbols in this manual

In this manual, hazard statements are indicated by symbols. The symbols are accompanied by a signal word that indicates the severity of the risk.



WARNING

Indicates a hazardous situation that could result in serious injury or death if it is not avoided.



CAUTION

Indicates a hazardous situation that could result in minor or slight injury if it is not avoided.



IMPORTANT

Indicates a hazardous situation that could result in damage to property if it is not avoided.



Gives useful tips, recommendations and information for efficient, trouble-free use.



This product complies with Directive 93/42/EEC concerning medical devices. The launch date of this product is stated in the CE declaration of conformity.



This symbol identifies a list of various tools, components and items which you will need in order to carry out certain work.

1.3 Type classification

The Orion^{METRO} has been classified according to EN 12184 as a **class B mobility product** (for indoor and outdoor areas). It is therefore compact and agile enough for indoor areas, but also able to overcome many obstacles in outdoor areas.

The Orion^{PRO} has been classified according to EN 12184 as a **class C mobility product** (outdoors). Because of its size it is less suitable for use in indoor environments, but has a longer driving range and the ability to overcome larger and more difficult obstacles in outdoor settings.

1.4 Intended use

This mobility device was designed for persons whose ability to walk is impaired, but who are still in terms of their eyesight and physically and mentally able to operate an electric mobility device.

1.5 Regulations

The vehicle was successfully tested according to German and international standards as to its safety. It satisfies the requirements according to RoHS 2011/65/EU, REACH 1907/2006/EC and DIN EN 12184 including EN 1021-2 and ISO 7176–14. It was also tested successfully according to EN 60529 IPX4 as to its resistance to spray water, and is therefore well suited for weather conditions such as typical European weather conditions. When equipped with an appropriate lighting system, the vehicle is suitable for use on public roads.

1.6 Warranty

The terms and conditions of the warranty are part of the general terms and conditions particular to the individual countries in which this product is sold.

1.7 Service life

We estimate a service life of five years for this product, provided it is used in strict accordance with the intended use as set out in this document and all maintenance and service requirements are met. The estimated service life can be exceeded if the product is carefully used and properly maintained, and provided technical and scientific advances do not result in technical limitations. The service life can also be considerably reduced by extreme or incorrect usage. The fact that we estimate a service life for this product does not constitute an additional warranty.

1.8 Limitation of liability

Invacare accepts no liability for damage arising from:

- Non-compliance with the user manual
- Incorrect use
- Natural wear and tear
- Incorrect assembly or set-up by the purchaser or a third party
- Technical modifications
- Unauthorized modifications and/or use of unsuitable spare parts

2 Safety

2.1 General safety notes

**WARNING!**

Risk of injury if mobility device is used in any other way than the purpose described in this manual

- Only ever use the mobility device in accordance with the instructions in this user manual.
- Pay strict attention to the safety information.

**WARNING!**

Risk of injury if the mobility device is driven when your ability to drive is impaired by medication or alcohol

- Never drive any vehicle under the influence of medication or alcohol.

**WARNING!**

Risk of damage or injury if the mobility device is accidentally set into motion

- Switch the power system off before you get in, get out or handle unwieldy objects.
- Be aware that the motor brakes are automatically deactivated when the motors are disengaged. For this reason, freewheel operation is only recommended on flat surfaces, never on gradients. Never leave your mobility device on a gradient with its motors disengaged. Always re-engage the motors immediately after pushing the mobility device.

**WARNING!**

Risk of injury if the power is switched off while the mobility device is in motion, due to it coming to an abrupt, sharp stop

- If you have to brake in an emergency, simply release the drive lever and allow the mobility device to come to a complete stop.
- If fitted, pull the handbrake until the mobility device comes to a stop.
- Only switch the mobility device off while in motion as a last resort.

**WARNING!**

Risk of injury if the mobility device is transported in another vehicle with the occupant seated in it

- Never transport the mobility device with the occupant seated in it.



WARNING!

Risk of injury if you fall off the mobility device

- If restraining systems are installed (such as seat belts), use them each time you drive the mobility device.



CAUTION!

Risk of injury if maximum permissible load is exceeded

- Do not exceed the maximum permissible load (refer to 12 Technical data, page 59).
- The mobility device is only designed for use by a single occupant whose maximum weight does not exceed the maximum permissible load of the device. Never use the mobility device to transport more than one person.



CAUTION!

Risk of injury due to wrong lifting or dropping of heavy components

- When maintaining, servicing or lifting any part of your mobility device, take into account the weight of the individual components especially the batteries. Be sure at all times to adopt the correct lifting posture and ask for assistance if necessary.



CAUTION!

Risk of injury by moving parts

- Make sure that no injury is incurred by moving parts of the mobility device, like wheels or a seat lifter (if fitted), especially when children are around.



CAUTION!

Risk of injury from hot surfaces

- Do not leave the mobility device in direct sunlight for prolonged periods. Metal parts and surfaces such as the seat and armrests can become very hot.



CAUTION!

Risk of fire or breaking down due to electric devices being connected

- Do not connect any electric devices to your mobility device that are not expressly certified by Invacare for this purpose. Have all electrical installations done by your authorized Invacare dealer.

2.2 Safety information on the electrical system



WARNING!

Risk of death, serious injury or damage

Misuse of the mobility device may cause the mobility device to start smoking, sparking, or burning. Death, serious injury, or damage may occur due to fire.

- DO NOT use the mobility device other than its intended purpose.
- If the mobility device starts smoking, sparking, or burning, discontinue using the mobility device and seek service IMMEDIATELY.



WARNING!

Risk of fire

Switched on lamps produce heat. If you cover the lamps with fabrics such as clothes, there is a risk that the fabric may catch fire.

- NEVER cover the light system with fabric.



WARNING!

Risk of death, serious injury or damage when carrying along oxygen systems

Textiles and other materials that normally would not burn are easily ignited and burn with great intensity in oxygen enriched air.

- Check the oxygen tubing daily, from the cylinder to the delivery site, for leaks and hold away from electrical sparks and any source of ignition.



WARNING!

Risk of injury or damage due to electrical shorts

Connector pins on cables connected to the power module can still be live even when the system is off.

- Cables with live pins should be connected, restrained or covered (with non-conductive materials) so that they are not exposed to human contact or materials that could cause electrical shorts.
- When cables with live pins have to be disconnected, for example, when removing the bus cable from the remote for safety reasons, make sure to restrain or cover the pins (with non-conductive materials).



WARNING!

Risk of death, serious injury, or damage

Corroded electrical components due to water or liquid exposure can result in death, serious injury, or damage.

- Minimize exposure of electrical components to water and/or liquids.
- Electrical components damaged by corrosion **MUST** be replaced immediately.
- Mobility devices that are frequently exposed to water/liquids may require replacement of electrical components more frequently.



WARNING!

Risk of death or serious injury

Failure to observe these warnings can cause an electrical short resulting in death, serious injury, or damage to the electrical system.

- The POSITIVE (+) RED battery cable MUST connect to the POSITIVE (+) battery terminal(s)/post(s). The NEGATIVE (-) BLACK battery cable MUST connect to the NEGATIVE (-) battery terminal(s)/post(s).
- NEVER allow any of your tools and/or battery cable(s) to contact BOTH battery post(s) at the same time. An electrical short may occur and serious injury or damage may occur.
- Install protective caps on positive and negative battery terminals.
- Replace cable(s) immediately if cable(s) insulation becomes damaged.
- DO NOT remove fuse or mounting hardware from POSITIVE (+) red battery cable mounting screw.



WARNING!

Risk of death or serious injury

Electric shock can cause death or serious injury

- To avoid electric shock, inspect plug and cord for cuts and/or frayed wires. Replace cut cords or frayed wires immediately.



Risk of damage to the mobility device

A failure in the electric system can lead to unusual behavior such as continuous light, no light, or noises from the magnetic brakes.

- If a failure exists, switch off the remote and switch it on again.
- If a failure still exists, then disconnect or remove the power source. Depending on the mobility device model, you can either remove the battery packs or disconnect the batteries from the power module. If in doubt which cable to disconnect, contact your provider.
- In any case, contact your provider.

2.3 Safety information on electromagnetic interference

This electric vehicle was successfully tested in accordance with International standards as to its compliance with Electromagnetic Interference (EMI) regulations. However, electromagnetic fields, such as those generated by radio and television transmitters, and cellular phones can influence the functions of electric vehicles. Also, the electronics used in our vehicles can generate a low level of electromagnetic interference, which however will remain within the tolerance permitted by law. For these reasons we ask you to please observe the following precautions:

**WARNING!****Risk of malfunction due to electromagnetic interference**

- Do not switch on or operate portable transceivers or communication devices (such as radio transceivers or cellular phones) when the vehicle is switched on.
- Avoid getting near strong radio and television transmitters.
- In case the vehicle should be set in motion unintentionally or the brakes are released, switch it off immediately.
- Adding electrical accessories and other components or modifying the vehicle in any way can make it susceptible to electromagnetic interference. Keep in mind that there is no sure way to determine the effect such modifications will have on the overall immunity of the electronic system.
- Report all occurrences of unintentional movement of the vehicle, or release of the electric brakes to the manufacturer.

2.4 Safety information on driving and freewheel mode

**WARNING!****Risk of injury if the mobility device tips over**

- Only ever negotiate gradients up to the rated slope and only with the backrest in an upright position, and the seat lifter in the lowest position (if installed).
- Only ever drive downhill at a maximum of 2/3 of the top speed. Avoid abrupt braking or accelerating on gradients.
- If at all possible, avoid driving on wet, slippery, icy, or oily surfaces (such as snow, gravel, ice etc.) where there is a risk of you losing control over the mobility device, especially on a gradient. This may include certain painted or otherwise treated wood surfaces. If driving on such a surface is inevitable, then always drive slowly and with the utmost caution.
- Never attempt to overcome an obstacle when on an uphill or downhill gradient.
- Never attempt to drive up or down a flight of steps.
- Always approach obstacles straight on. Ensure that the front wheels and rear wheels move over the obstacle in one stroke, do not stop halfway. Do not exceed the maximum obstacle height (refer to 12 Technical data, page 59).
- Avoid shifting your center of gravity as well as abrupt changes of direction when the mobility device is in motion.



WARNING!

Risk of injury if the mobility device tips over (continued)

- Never use the mobility device to transport more than one person.
- Do not exceed the maximum permissible load.
- When loading the mobility device, always distribute the weight evenly. Always try to keep the center of gravity of the mobility device in the middle, and as close to the ground as possible.
- Note that the mobility device will brake or accelerate if you change the driving speed while it is in motion.



WARNING!

Risk of injury if you collide with an obstacle when driving through narrow passages such as doorways and entrances

- Drive through narrow passages in the lowest driving speed and with due caution.



WARNING!

The center of gravity of the scooter is higher than that of a power wheelchair.

There is an increased tipping risk when negotiating bends.

- Reduce speed before negotiating bends. Only accelerate when you have come out of the bend.
- Be aware that the seat height strongly influences the center of gravity. The higher the seat height, the higher the risk of tipping.



**WARNING!****Risk of tipping**

Antitippers (stabilizers) are only effective on firm ground. They sink in on soft ground such as grass, snow or mud if the mobility device rests itself on them. They lose their effect and the mobility device can tip over.

- Only drive with extreme care on soft ground, especially during uphill and downhill journeys. In the process pay increased attention to the tip stability of the mobility device.

**CAUTION!**

It may be difficult to turn in front of a lift or building entrance because the scooter turning circle may not necessarily comply with building standards

- Always be aware of the limitations of your scooter, particularly the turning circle capabilities when entering a building or a lift. Avoid driving situations in which you would no longer be able to come out because you cannot turn your scooter around.

2.5 Safety information with regard to care and maintenance

**WARNING!****Risk of death, serious injury, or damage**

Incorrect repair and/or servicing of this mobility device performed by users/caregivers or unqualified technicians can result in death, serious injury, or damage.

- DO NOT attempt to carry out maintenance work that is not described in this user manual. Such repair and/or service **MUST** be performed by a qualified technician. Contact a provider or Invacare technician.



CAUTION!

Risk of accident and loss of warranty if maintenance is insufficient

- For reasons of safety and in order to avoid accidents which result from unnoticed wear, it is important that this mobility device undergoes an inspection once every year under normal operating conditions (see inspection plan contained in service instructions).
- Under difficult operating conditions such as daily travel on steep slopes, or in the case of use in medical care cases with frequently changing mobility device users, it would be expedient to carry out intermediate checks on the brakes, accessories and running gear.
- If the mobility device is to be operated on public roads, the vehicle driver is responsible for ensuring that it is in an operationally reliable condition. Inadequate or neglected care and maintenance of the mobility device will result in a limitation of the manufacturer's liability.

2.6 Safety information regarding changes and modifications to the mobility device



CAUTION!

Risk of serious injury or damage

- Use of incorrect or improper replacement (service) parts may cause injury or damage
- Replacement parts **MUST** match original Invacare parts.
 - Always provide the serial number of the mobility device to assist in ordering the correct replacement parts.



CAUTION!

Risk of injuries and damage to mobility device due to unapproved components and accessory parts

Seating systems, additions and accessory parts which have not been approved by Invacare for use with this mobility device can affect the tipping stability and increase tipping hazards.

- Only ever use seating systems, additions and accessory parts which have been approved by Invacare for this mobility device.

Seating systems which are not approved by Invacare for use with this mobility device do not, under certain circumstances, comply with the valid standards and could increase the flammability and the risk of skin irritation.

- Only use seating systems that have been approved by Invacare for this mobility device.

Electrical and electronic components which have not been approved by Invacare for use with this mobility device can cause fire hazards and lead to electromagnetic damage.

- Only ever use electrical and electronic components which have been approved by Invacare for this mobility device.

Batteries which have not been approved by Invacare for use with this mobility device can cause chemical burns.

- Only ever use batteries which have been approved by Invacare for this mobility device.



CE marking of the mobility device

- The conformity assessment/CE marking was carried out in accordance with Directive 93/42 EEC and only applies to the complete product.
- The CE marking is invalidated if components or accessories are replaced or added that have not been approved for this product by Invacare.
- In this case, the company that adds or replaces the components or accessories is responsible for the conformity assessment/CE marking or for registering the mobility device as a special design and for the relevant documentation.









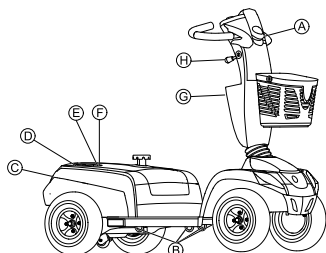

Important information about maintenance work tools

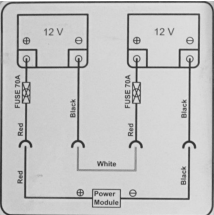
- Some maintenance work which is described in this manual and can be carried out by the user without problems require the correct tools for proper work. If you do not have the correct tool available we do not recommend that you try to carry out the relevant work. In this case, we urgently recommend that you contact an authorized specialist workshop.



2.7 Labels on the product





A		<p>Identification of charger socket (left-hand side of steering column, not visible in picture).</p>
B		<p>Identification of transport fixation hooks.</p>
C		<p>Battery label under the cover at the rear.</p>

D		<p>Identification of the position of the coupling lever for driving and push operation.</p>
E		<p>European representative label on the chassis at the rear.</p>
F		<p>Identification label sticker on the chassis at the rear. For details see below.</p>
G		<p>Warning that the mobility device may not be used as a vehicle seat. This mobility device does not satisfy the requirements of ISO 7176-19.</p>
H		<p>Warning that the lever for adjusting the steering column may not be used as a hook.</p>

Explanation of symbols on labels

	Date of manufacture
	This product complies with Directive 93/42/EEC concerning medical devices. The launch date of this product is stated in the CE declaration of conformity.
	The product needs to be tied down at indicated anchor points with a lashing system during transport.

	<p>This product has been supplied from an environmentally aware manufacturer. This product may contain substances that could be harmful to the environment if disposed of in places (landfills) that are not appropriate according to legislation.</p> <ul style="list-style-type: none"> • The 'crossed out wheeled bin' symbol is placed on this product to encourage you to recycle wherever possible. • Please be environmentally responsible and recycle this product through your recycling facility at its end of life.
--	--

	<p>This symbol indicates the “Drive” position of the coupling lever. In this position the motor is engaged and the motor brakes are operational. You can drive the mobility device.</p>
	<p>This symbol indicates the “Push” position of the coupling lever. In this position the motor is disengaged and the motor brakes are not operational. The mobility device can be pushed by an attendant and the wheels turn freely.</p>

3 Components

3.1 Main parts of the scooter

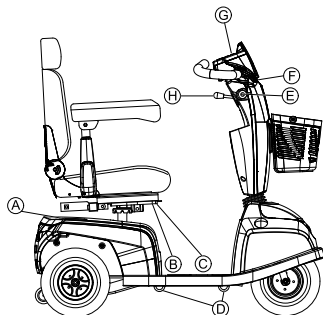

(A)	Disengaging lever
(B)	Unlocking lever for sliding seat rails (front right below seat)
(C)	Unlocking lever for swivelling and removing seat (left under the seat, not visible in picture)
(D)	Transport fixation hooks
(E)	Keyswitch (ON/OFF)
(F)	Brake lever (right-hand lever)
(G)	Operating console (LED or LCD)
(H)	Lever for adjusting steering column angle

3.2 Operating console (LED version)

Arrangement

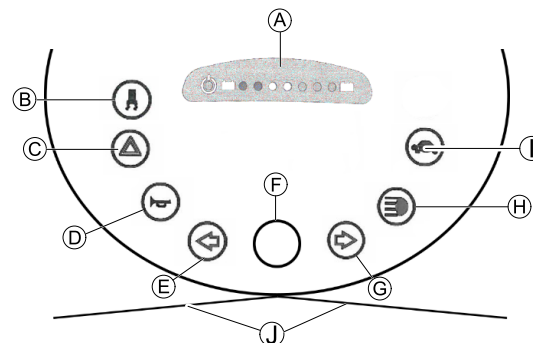

(A)	Status display
(B)	Switching on/off curve control (reduction of speed when driving in a curve)
(C)	Hazard lights
(D)	Horn
(E)	Left-hand direction indicator (switches itself off automatically after 30 seconds)
(F)	Speed control dial
(G)	Right-hand direction indicator (switches itself off automatically after 30 seconds)
(H)	Lighting

①	Low speed mode
①	Drive lever

Status display

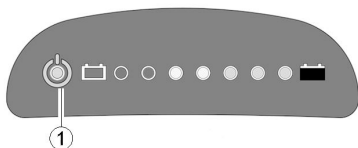

i The ON/OFF diode (1) is used as a fault display (status display). It will flash if there is a problem with the scooter. The number of flashes indicates the type of error. Refer to 11.1.2 Error codes and diagnostic codes, page 57.

Battery indication gauge

i Low battery indication: Every time the scooter is activated or at work when battery capacity is lower than 25%, the electronic system will beep three times.

i Overdischarge protection: after a certain drive time on reserve battery power the electronic system switches the drive off automatically and brings the scooter to a standstill. If you do not drive your scooter for a while the batteries will "recuperate" and allow a further, but short, journey. However, after a very brief journey the battery reserve symbol will illuminate again and the electronic system will beep three times. This procedure leads to battery damage and should be avoided if possible!

Battery capacity: <25%	Reduced driving range. Recharge the batteries at the end of your journey.
Battery capacity: <20%	Battery reserve = severely restricted driving range. Recharge batteries immediately!

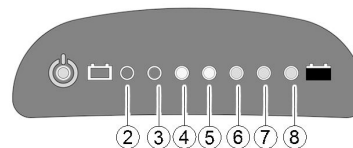

(2)	(3)	(4)	(5)	(6)	(7)	(8)	Battery capacity
☀	☀	☀	☀	☀	☀	☀	>80%
☀	☀	☀	☀	☀	☀		<80%
☀	☀	☀	☀	☀			<65%

(2)	(3)	(4)	(5)	(6)	(7)	(8)	Battery capacity
☀	☀	☀	☀				<50%
☀	☀	☀					<35%
☀	☀						<25%
☀							<20%

3.3 Operating console (LCD version)

Arrangement

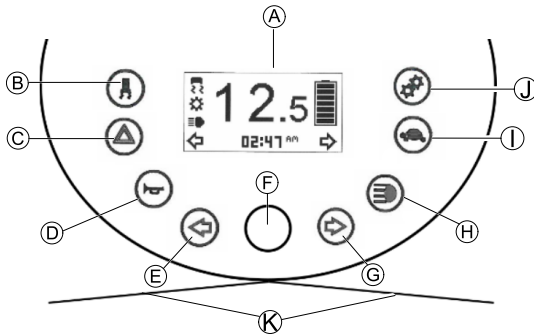

(A)	Status display
(B)	Switching on/off curve control (reduction of speed when driving in a curve)
(C)	Hazard lights
(D)	Horn

(E)	Left-hand direction indicator (switches itself off automatically after 30 seconds)
(F)	Speed control dial
(G)	Right-hand direction indicator (switches itself off automatically after 30 seconds)
(H)	Lighting
(I)	Low speed mode
(J)	Setting
(K)	Drive lever

Status display



(A)	Speed indication
(B)	Fault indication
(C)	Curve control indication
(D)	Maintenance indication ¹
(E)	Head light indication
(F)	Left turn indication

ⓐ	Settings shown: ODO, TRIP, TEMP, TIME
ⓑ	Right turn indication
ⓒ	Battery status
ⓓ	Low speed selection indication







Battery capacity: <25%	Reduced driving range. Recharge the batteries at the end of your journey.
Battery capacity: <20%	Battery reserve = severely restricted driving range. Recharge batteries immediately!

1If this symbol starts flashing for one minute every time the scooter is switched on, contact your provider.

Battery indication gauge

 Low battery indication: Every time the scooter is activated or at work when battery capacity is lower than 25%, the electronic system will beep three times.

 Overdischarge protection: after a certain drive time on reserve battery power the electronic system switches the drive off automatically and brings the scooter to a standstill. If you do not drive your scooter for a while the batteries will "recuperate" and allow a further, but short, journey. However, after a very brief journey the battery reserve symbol will illuminate again and the electronic system will beep three times. This procedure leads to battery damage and should be avoided if possible!

						
>80%	<80%	<65%	<50%	<35%	<25%	<20%

4 Setup

4.1 General setup information



WARNING!

Risk of death, serious injury, or damage

Continued use of the mobility device that is not set to the correct specifications may cause erratic behavior of the mobility device resulting in death, serious injury, or damage.

- Performance adjustments should only be made by professionals of the healthcare field or persons fully conversant with this process and the driver's capabilities.
- After the mobility device has been set-up/adjusted, check to make sure that the mobility device performs to the specifications entered during the set-up procedure. If the mobility device does not perform to specifications, IMMEDIATELY turn the mobility device Off and re-enter set-up specifications. Contact Invacare, if mobility device still does not perform to correct specifications.



WARNING!

Risk of death, serious injury, or damage

Attaching hardware that is loosely secured or missing could cause instability resulting in death, serious personal injury, or property damage.

- After ANY adjustments, repair or service and before use, make sure that all attaching hardware is present and tightened securely.



WARNING!

Risk of injury or damage

Incorrect set up of this mobility device performed by users/caregivers or unqualified technicians can result in injury or damage.

- DO NOT attempt to set up this mobility device. Initial set up of this mobility device MUST be performed by a qualified technician.
- Adjustment by the user is only recommended after they have been given appropriate guidance by the healthcare professional.
- DO NOT attempt to carry out the work if you do not have the listed tools available.





CAUTION!

Damage to mobility device and accident hazard

It is possible that collisions can occur between mobility device components due to various combinations of adjustment options and their individual settings

- The mobility device is fitted with an individual, multiply adjustable seating system including adjustable legrests, armrests, a headrest or other options. These adjustment options are described in the following chapters. They are used to adapt the seat to the physical requirements and the condition of the user. When adapting the seating system and the seat functions to the user, ensure that no mobility device components collide.

 Initial setup should always be done by a healthcare professional. Adjustment by the user is only recommended after they have been given appropriate guidance by the healthcare professional.

 Note that there may be sections in this user manual, which are not relevant to your product, since this manual applies to all existing modules (on the date of printing).

4.2 Moving the seat position forwards or backwards

The disengaging lever for adjusting the seat is located front right below the seat.

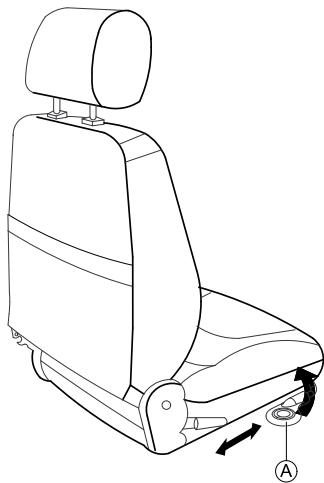

1. Pull the lever  to disengage the seat.
2. Slide the seat forwards or backwards into the required position.
3. Release the lever to lock the seat into the required position.

4.3 Adjusting the armrest width



WARNING!

Serious injury

If one of the armrests is adjusted to a width which exceeds the permissible value the armrest falls out of its brackets which could lead to serious injury.

- The width adjustment is fitted with small stickers with markings and the word “STOP”. The armrest must never be pulled out further than the point at which the word “STOP” is completely legible.
- Always tighten the fixing screws properly once adjustments have been completed.

The knobs for releasing the armrests are located under the seat.

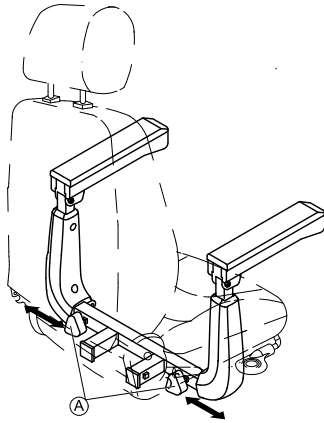

1. Turn the knobs **A** to loosen the fixing for the armrest.
2. Adjust the armrests to the required width.
3. Retighten the knobs.

4.4 Adjusting the armrest height



- Phillips screwdriver

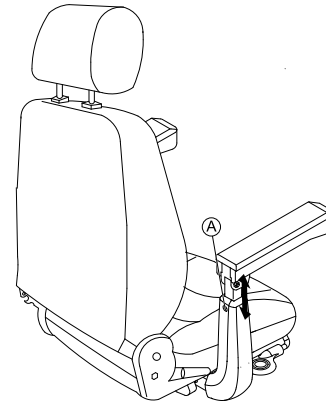

1. Loosen and remove the armrest fixing screw **A**.
2. Adjust the armrest to the required height.
3. Insert the screw and tighten again.

4.5 Adjusting the armrest angle



- 6 mm Allen key
- 13 mm wrench

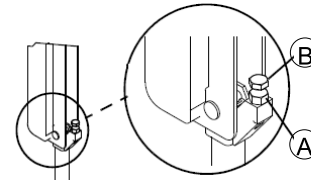



1. Swivel up the armrest.
2. Use the socket wrench to loosen the counter nut **A**.

- Adjust the screw (B) until the desired setting angle of the armrest has been achieved.
- Re-tighten the counternut.

4.6 Adjusting backrest angle

Comfort seat

-
- | | |
|--|------------------|
|  | • 5 mm Allen key |
|  | • 10 mm wrench |
-

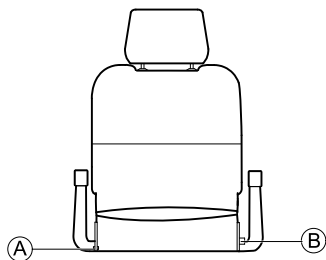

- Remove screw (A) on one side of the seat.
- Set backrest to desired angle by selecting one of two holes in metal fixation plate.
- Insert screw and tighten it.
- Pull out pin (B) and move backrest to desired angle. Pin snaps into place automatically.

Deluxe & Premium seat

The lever (A) for adjusting the backrest angle is located on the left of the seat.

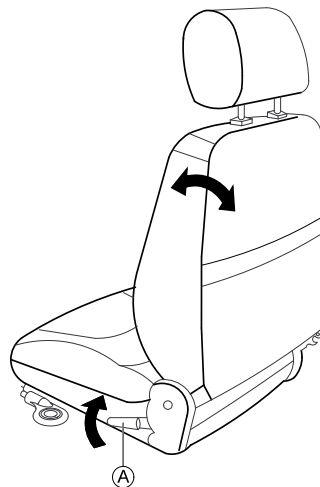

- Pull lever and adjust backrest to desired angle by leaning forwards or backwards.

4.7 Adjusting the headrest

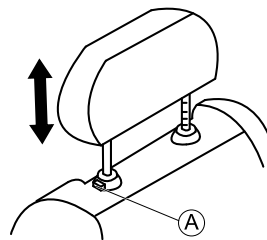

1. To raise headrest, push the release button (A) and lift headrest up to desired position.
2. To lower headrest, push the release button and lower headrest to the desired position.

4.8 Disengaging the seat to rotate or remove it

The seat can be turned to one side to make getting in and out of the scooter easier. The seat is also easier to remove from this position.

The seat lever is located under the seat on the left .

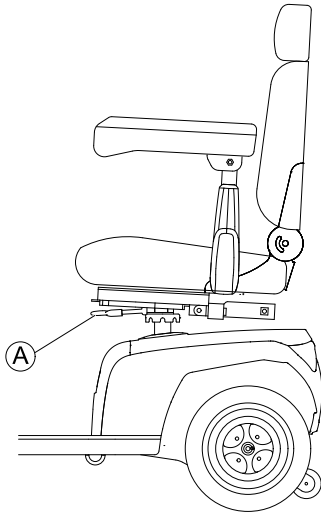

Rotating the seat

1. Pull the lever (A) to disengage the seat.
2. Turn the seat to the side.

1638629-A

Removing the seat

1. Pull the lever (A) to disengage the seat.
2. Hold the seat firmly by the backrest and front edge and remove it upwards.



Installing the seat

1. Lower the seat assembly onto the seat post.
2. Allow the seat to drop into the locked position.
3. Lift up the seat assembly to ensure the seat is secured.

4.9 Adjusting the angle of the steering column

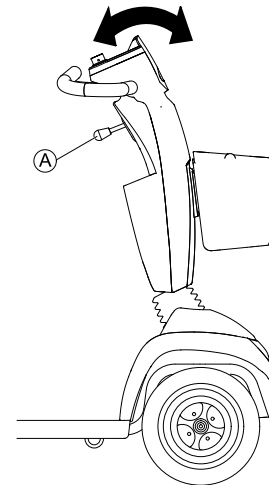
The angle of the steering column can be adjusted to your personal requirements to ensure a good seating position while driving the scooter.



1. Push the lever  downwards to adjust the steering column.
2. Hold the lever and move the steering column forwards or backwards until it fits to your requirements.
3. Release the lever.
 -  The lever automatically switches back to its position. The moment you release the lever, the steering column is fixed.

5 Accessories

5.1 Posture belts

A posture belt is an option which can either be fixed to the mobility device ex-works or can be retrofitted by your specialist provider. If your mobility device is fitted with a posture belt, your specialist provider will have informed you about fitting and usage.

The posture belt is used to help the mobility device user keep an optimum seating position. Correct use of the belt assists the user in sitting securely, comfortably and well-positioned in the mobility device, especially for such users who do not have such a good sense of balance while sitting.



We recommend using the posture belt whenever the mobility device is used.

5.1.1 Types of posture belts

Your mobility device can be fitted with the following posture belt types ex-works. If your mobility device has been fitted with a different belt to those listed below, please ensure that you have received the manufacturer's documentation with regard to correct fitting and use.

Belt with metal buckle adjustable on one side



The belt can only be adjusted on one side, which can result in the buckle not being in the middle of the waist (across pelvic area) after adjustment has taken place.

5.1.2 Adjusting the posture belt correctly



The belt should be tight enough to ensure that you are sitting comfortably and that your body is in the correct sitting position.

1. Ensure that you are sitting correctly, which means that you are sitting right at the back of the seat, your pelvis is positioned erect and as symmetrically as possible, not to the front, to the side or at one edge of the seat.
2. Position the posture belt so that your hipbones can be easily felt above the belt.
3. Adjust the belt length using one of the adjustment aids described above. The belt should be adjusted so that you can fit a flat hand between the belt and your body.
4. The buckle should be positioned as centrally as possible. In doing so, carry out adjustments on both sides as much as possible.
5. Check your belt every week to ensure that it is still in good working condition, to ensure it has no damage or wear, and that it is fixed properly to the mobility device. If the belt is only fastened with a bolted connection, ensure that the connection has not loosened or come undone. You can find more information about maintenance work on belts in the service manual, which is available from Invacare.

5.1.3 Installing the posture belt

- 12 mm wrench
 - 13 mm wrench
-

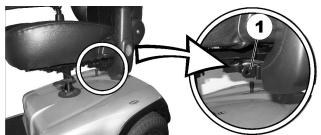

The mounting brackets (1) for attaching the belt, are located under the seat (the figure shows only the left hand side).

1. Take hold of the belt mounting and hold it in front of the hole in the mounting bracket.
- 2.

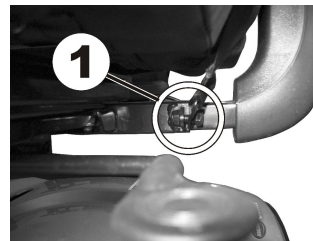

Position the bolt (1), screw the nut on from the other side and tighten with a wrench.

- 3.



Repeat steps 1–2 on the opposite side of the seat with the remaining side of the posture belt. Check to ensure that the nut is tightened properly on the bolt.

5.2 Rollator bracket

Your scooter can be fitted with an optional rollator bracket. Only the following rollators, which have been approved by Invacare, can be transported using this bracket:

- Dolomite Jazz 600
- Dolomite Legacy 600
- Invacare Banjo P452E/3

The maximum permitted rollator weight is 9 kg.



CAUTION!

Risk of tipping as a result of altered center of gravity

The center of gravity of the scooter shifts towards the back as a result of attaching the rollator. The maximum safe angle of incline is thereby reduced by up to 2°.

- Note that gradients that you would normally be able to negotiate may now be too steep and the scooter could tip. Do not attempt to climb or descend such gradients.

5.2.1 Attaching the rollator

Dolomite Jazz 600

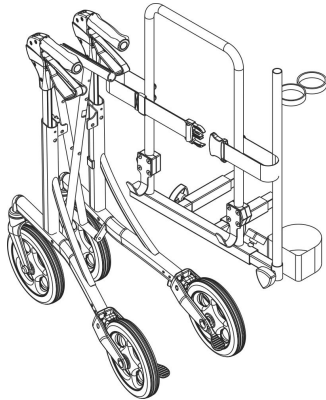

Dolomite Legacy 600

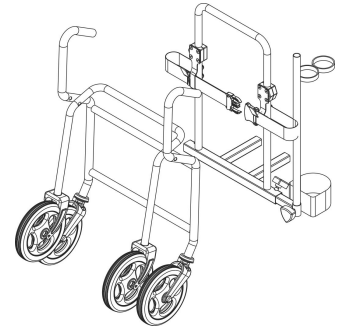

Invacare Banjo P452E/3

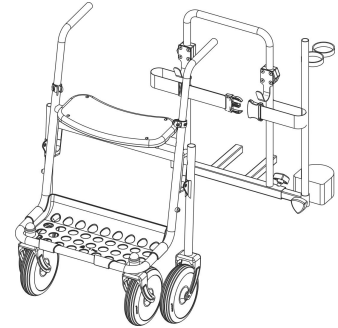

5.2.2 Removing the rollator bracket

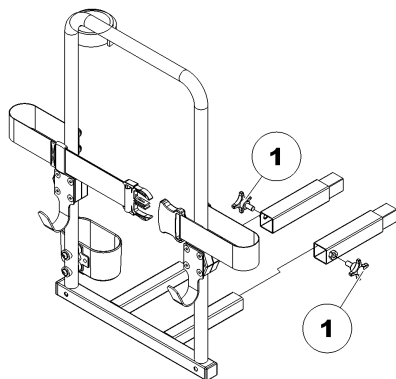

1. Loosen the screws (1).
2. Pull the rollator bracket out of the fixtures.

5.2.3 Positioning the rear reflector



CAUTION!

Risk of accident due to poor visibility

If you wish to use your mobility device on public roads and a rear reflector is required by national legislation, then the rollator bracket may not cover the rear reflector.

- Make sure that the rear reflector is mounted in such a way that a sufficient amount of the reflective area is visible.

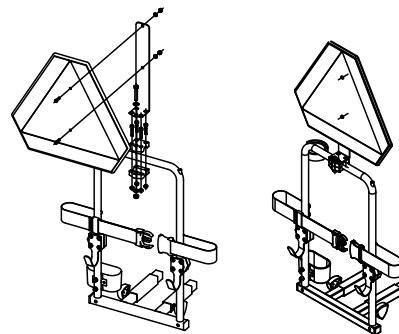

1. Position the rear reflector as shown in the drawing.

5.3 Changing the colored shrouds

It is possible to change the color of your scooter by replacing the colored shrouds.

1. Remove the existing shrouds carefully.
2. Place the plastic nose (A) into the intended holes (B) and click in the new shrouds.

Change the armrest shroud

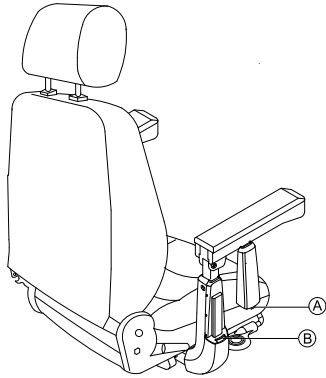

Change the rear side shroud

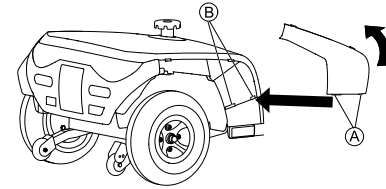

Change the head shroud

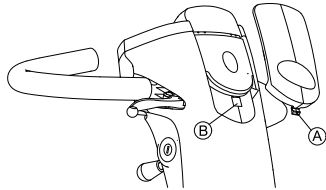

Change the front side shroud

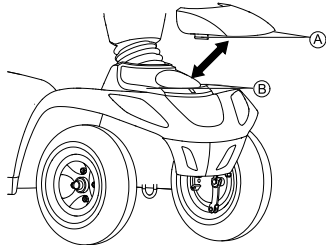

6 Usage

6.1 Getting in and out

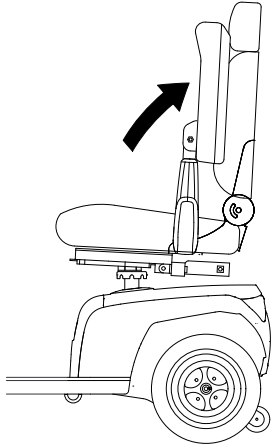

The armrest can be swivelled upwards to assist getting in and out.

The seat can also be rotated to assist getting in and out.

1.

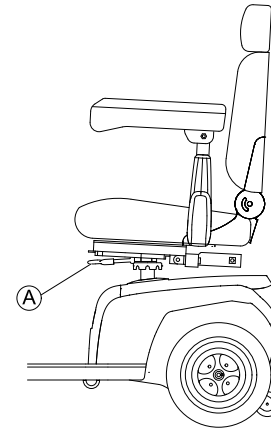

Pull the detent lever (A).

2.

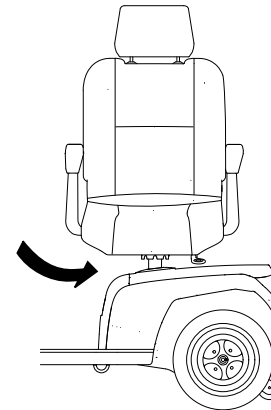

Turn the seat to the side.



Information on turning the seat

The detent automatically engages again in eight-turns.

6.2 Before driving for the first time

Before you take your first trip, you should familiarize yourself well with the operation of the mobility device and with all operating elements. Take your time to test all functions and driving modes.



If installed, make sure to properly adjust and use the posture belt each time you use the mobility device.

Sitting comfortably = Driving safely

Before each trip, make sure that:

- You are within easy reach of all operating controls.
- The battery charge is sufficient for the distance intended to be covered.
- The posture belt (if installed) is in perfect order.
- The rear mirror (if installed) is adjusted so you can look behind at all times without having to bend forward or shift your seating position.

6.3 Taking Obstacles

6.3.1 Maximum obstacle height

You can find information about maximum obstacle heights in the chapter entitled 12 Technical data, page 59.

6.3.2 Safety information when ascending obstacles



WARNING!

Risk of tipping over

- Never approach obstacles at an angle but at 90 degrees as shown below.
- Put your backrest into an upright position before climbing an obstacle.

6.3.3 The correct way to overcome obstacles

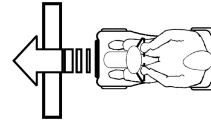

Right

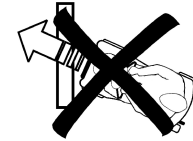

Wrong

Driving up over an obstacle

1. Approach the curb or obstacle slowly head-on. Shortly before the front wheels touch the obstacle, increase the speed and reduce only after the rear wheels have also climbed the obstacle.

Driving down off of an obstacle

1. Approach the curb or obstacle slowly head-on. Before the front wheels touch the obstacle, reduce speed and keep it until also the rear wheels have come down off of the obstacle.

6.4 Driving up and down gradients

For information concerning the rated slope, refer to 12 Technical data, page 59.



WARNING!

Risk of tipping over

- Only ever drive downhill at a maximum of 2/3 of the top speed.
- If your scooter is fitted with an adjustable backrest, always return the backrest of your seat to an upright position before ascending slopes. We recommend that you lean the backrest slightly to the rear before descending slopes.
- When descending slopes, bring your seat to a maximum forward position.
- Never attempt to ascend or descend a slope on slippery surfaces or where there is a danger of skidding (such as wet pavement, ice etc).
- Avoid trying to get out of the scooter on an incline or a gradient.
- Always drive in a straight direction along the road or path you are travelling on, rather than attempting to zigzag.
- Never attempt to turn around on an incline or a slope.



CAUTION!

Braking distance is much longer on a downhill slope than on even terrain

- Never drive down a slope that exceeds the rated slope (refer to 12 Technical data, page 59).

6.5 Parking and stationary

If you park your vehicle, or leave it idle or unattended for a longer period:

1. Switch off the power supply (keyswitch) and remove key.

6.6 Use on public roads

The wheels may bear the note "Not For Highway Use". However, the mobility device may be used on all traffic routes for which it is approved in accordance with the relevant national legislation.

6.7 Pushing the scooter by hand



CAUTION!

Risk of injury if someone sits on a scooter with disengaged motors

- A scooter with disengaged motors can roll out of control.
- Disengage the motors only if no one is sitting on the scooter.

The motors of the scooter are fitted with automatic brakes, preventing the scooter from rolling away out of control when the power supply is switched off. When pushing the scooter, the magnetic brakes must be disengaged.

6.7.1 Disengaging motors



CAUTION!

Risk of vehicle running away

When the motors are disengaged (for push operation whilst freewheeling), the electromagnetic motor brakes are deactivated.

- When the vehicle is parked, the levers for engaging and disengaging the motors must be locked firmly into the “DRIVE” position (electromagnetic motor brakes activated).

The lever for engaging and disengaging the motor is located on the right-hand side at the rear.

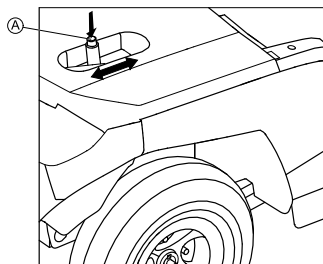

Disengaging the drive

1. Switch off the scooter (keyswitch).
2. Press the unlocking knob **A** on the disengaging lever.
3. Push the disengaging lever forwards.
The drive is disengaged. The scooter can be pushed by hand now.

Engaging the drive

1. Pull the lever to the rear.
The drive is engaged.

6.8 Driving the scooter



WARNING!

Risk of injury from the unintended rolling of the vehicle

When stopping the vehicle, the drive lever needs to return entirely to the middle position to activate the electromagnetic brakes. If there is any obstruction stopping the lever from returning to the middle position, the electromagnetic brakes cannot be activated. This can lead to the vehicle rolling unintentionally.

- Ensure that the drive lever is in the middle position, if the vehicle is to remain stationary.

1. Switch the power supply on (keyswitch).
The operating console display illuminates. The scooter is ready to drive.



If the scooter is not ready to drive after switching on, check the status display (refer to 3.3 Operating console (LCD version), page 21 and 11.1 Diagnosis and fault repair, page 56).

2. Set the required speed with the speed controller.
3. Pull the right-hand drive lever carefully to travel forwards.
4. Pull the left-hand drive lever carefully to travel in reverse.

 The control system is programmed with standard values in the works. Your Invacare provider can carry out programming tailored to fit your requirements.



WARNING!

Any changes to the drive program can affect the driving characteristics and the tipping stability of the vehicle.

- Changes to the drive program may only be carried out by trained Invacare providers.
- Invacare supplies all mobility products with a standard drive program ex-works. Invacare can only give a warranty for safe vehicle driving behavior - especially the tipping stability - for this standard drive program.

 To brake quickly, simply let go of the drive lever. It will then automatically return to the middle position. The scooter will brake.

To brake in an emergency, follow the above and pull the handbrake lever until the scooter comes to a halt.

6.9 Switching the lights on and off



1. Press the Light key.
The light is switched on or off.

When the light is switched on, the LED beside the key and the Light symbol in the LCD display (if fitted) illuminate.

6.10 Switching the direction indicator on and off



1. Press the Direction indicator key for left or right.
The direction indicator is switched on or off.

When the direction indicator is switched on, the LED beside the key and the Direction indicator symbol in the LCD display (if fitted) illuminate. According to the setup an acoustic signal sounds. The direction indicator switches itself off automatically after 30 seconds.

6.11 Switching the hazard lights on and off



1. Press the Hazard lights key.
The hazard lights are switched on or off.

When the hazard lights are switched on, the LEDs beside the Direction indicator keys and the Hazard light symbol in the LCD display (if fitted) illuminate. According to the setup an acoustic signal sounds.

6.12 Using the horn



1. Press the horn key.

An acoustic signal sounds.

6.13 Switching the low speed mode on and off

Your scooter is fitted with a low speed mode. This function lowers the scooter's speed.



1. Press the Low speed key.
The low speed mode is switched on or off.

When the low speed mode is switched on, the LED beside the key and the Low speed symbol in the LCD display (if fitted) illuminate.

6.14 Activating and deactivating curve control during bend travel

If your scooter is fitted with automatic curve control it is activated as standard when the scooter is switched on. This function lowers the scooter's speed as soon as you start driving round a bend. It is primarily designed for inexperienced users who may feel unsure of the scooter's dynamic driving behavior in a bend. If, however, you are an experienced user, you may wish to deactivate this function.



You need to be aware that deactivating this function will lead to a different dynamic driving behavior. Be careful when driving round a bend.

Deactivating curve control



1. Press the setting key for five seconds. The LED beside the key and the symbol for curve control in the LCD display (if fitted) illuminate. Curve control is deactivated.

Activating curve control

- 1.



Press the setting key. The LED beside the key and the symbol for curve control in the LCD display (if fitted) go out. Curve control is activated.

6.15 Mode selection

In the LCD display you can switch between four different modes.

ODO mode:	Displays the total distance driven by the scooter.
TRIP mode:	Displays the distance, driven since the last reset.
TEMP mode:	Displays the temperature.
TIME mode:	Displays the time.

Switching between modes

1. Press the setting key to switch between the modes, shown in the display.

Adjusting modes

You can adjust the modes to your requirements.



1. Press the setting key to choose the mode you want to adjust.



2. Press both direction indicator keys for two seconds. Depending on the mode do one of the following:



- a. ODO mode: Press left indicator key to select mile>>km>>hour.



- b. TRIP mode: Press both direction indicator keys to reset last trip.



- c. TEMP mode: Press left indicator key to select °C or °F.



- d. TIME mode: Press right indicator key to select hour or minutes.



Press left indicator key to change time.

3. Wait 15 seconds or press any other key except for the direction indicator keys, to save the settings.

6.16 Adjusting the display

Activating or deactivating acoustic signals

The scooter controls can be programmed to emit an acoustic signal in the following situations:

- Using the horn.
- Battery capacity low (activated in delivery status).
- Direction indicators activated (activated in delivery status).
- Hazard lamps activated (activated in delivery status).
- Reverse gear activated (both reverse gear and acoustic signal are activated in delivery status).

LED display

The controls must be switched off in order to activate or deactivate an acoustic signal for particular functions, and a particular keystroke combination needs to be entered when switching on again.

After a signal for a particular function has been successfully activated/deactivated, a combination of LEDs on the battery charge display flash as confirmation. The LEDs are numbered as shown below.

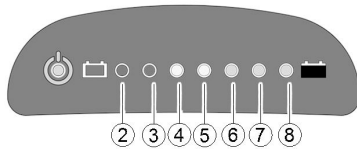

The keystroke combinations and LED codes for various options are as follows:

Function	Keystroke combination	LED(s)	Condition
Acoustic signal at low battery capacity	Lighting + direction indicator left	2	activated
		2+3	deactivated
Acoustic signal when direction indicators activated	Lighting + direction indicator right	4	activated
		4+5	deactivated

Function	Keystroke combination	LED(s)	Condition
Acoustic signal when hazard lamps activated	Lighting + hazard lamps	6	activated
		6+7	deactivated
Acoustic signal when reverse gear activated	Lighting + Speed reduction	2+3+4	activated
		5+6+7	deactivated

Proceed as follows to activate or deactivate an acoustic signal for a particular function:

1. Switch off the controls.



2. Press and hold both direction indicator keys.
3. Switch on the controls.
4. Wait two seconds until the appropriate flash code displays on the battery charge display, then release the keys. Do not hold the keystroke combination down for more than five seconds.
5. If LED 7 flashes five times subsequently, the acoustic signal has been successfully activated or deactivated.
6. The controls return to normal operating status automatically.

LCD display

If your scooter is fitted with an LCD display, you can either activate, deactivate or change the volume of the acoustic signals.

1. Switch off the controls.



2. Press and hold both direction indicator keys (A) and (B).
3. Switch on the controls.
4. The Buzzer Volume setup page illuminates after two second

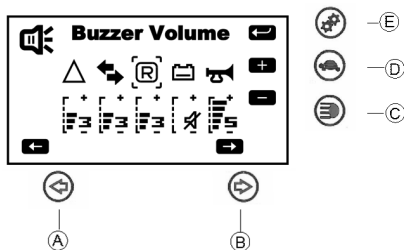

- a. Press the indicator keys (A) or (B) for the buzzer selection.
- b. Press Lighting key (C) for decreasing the volume.
- c. Press Low speed key (D) for increasing the volume.
- d. Press Setting mode key (E) for saving and enter the next setup page.

Adjusting backlight (only LCD display)

- 1.

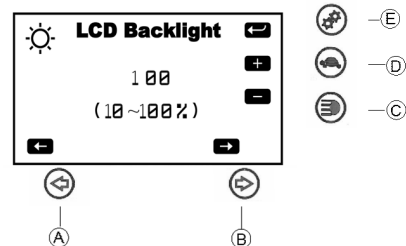

Press the indicator keys (A) or (B) to adjust the backlight intensity.

2. Press Setting mode key (E) for saving and enter the next setup page.

Adjusting time setup (only LCD display)

1.

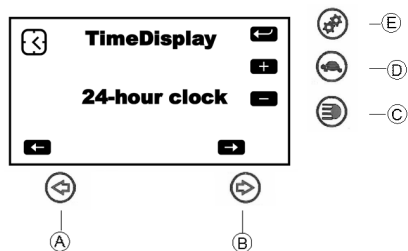

Press the indicator keys **A** or **B** to adjust the time setup.

2. Press Setting mode key **E** for saving.

7 Controls system

7.1 Controls protection system

The scooter controls is fitted with an overload protection.

If the drive is severely overloaded over a long period of time (for example, when driving up a steep hill) and especially when the ambient temperature is high, the electronic system could overheat. In this case the scooter performance is gradually reduced until it comes to a halt. The status display shows a corresponding error code (refer to 11.1.2 Error codes and diagnostic codes, page 57). By switching the power supply off and back on again, the error code is cleared and the controls is switched back on. It can however take up to five minutes until the controls has cooled down enough for the drive to restore full performance again.

If the drive is stalled by an insurmountable obstacle, for example, a curb or similar which is too high, and the driver attempts driving for more than 20 seconds against this obstacle, the controls automatically switches off to prevent the motors from being damaged. The status display shows a corresponding error code (refer to 11.1.2 Error codes and diagnostic codes, page 57). By switching off and back on again, the error code is cleared and the controls is switched back on.

7.1.1 The main fuse

The entire electrical system is protected against overload by two main fuses. The main fuses are mounted on the positive battery cables.



A defective main fuse may be replaced only after checking the entire electrical system. A specialized Invacare provider must perform the replacement. You can find information on the fuse type in 12 Technical data, page 59.

7.2 Batteries

Power is supplied by two 12 V batteries. The batteries are maintenance-free and only need regular charging.

In the following, you find information on how to charge, handle, transport, store, maintain, and use batteries.

7.2.1 General information on charging

New batteries should always be fully charged once before their first use. New batteries will be at their full capacity after having run through approx. 10 - 20 charging cycles (break-in period). This break-in period is necessary to fully activate the battery for maximum performance and longevity. Thus, range and running time of your mobility device could initially increase with use.

Gel/AGM lead acid batteries do not have a memory effect as NiCd batteries.

7.2.2 General instructions on charging

Follow the instructions listed below to ensure safe use and longevity of the batteries:

- Charge 18 hours prior to initial usage.

- We recommend charging the batteries daily after every discharge even after partly discharge, as well as each night over night. Depending on the level of discharge, it can take up to 12 hours until the batteries are fully charged again.
- When the battery indicator reached the red LED range, charge the batteries for 16 hours minimum, neglecting the charge complete display!
- Try to provide a 24 hour charge once a week to make sure that both batteries are fully charged.
- Do not cycle your batteries at a low state of charge without regularly recharging them fully.
- Do not charge your batteries under extreme temperatures. High temperatures above 30 °C are not recommended for charging as well as low temperatures below 10 °C.
- Use only charging devices in Class 2. This class of chargers may be left unattended during charging. All charging devices which are supplied by Invacare comply with these requirements.
- You cannot overcharge the batteries when using the charger supplied with your mobility device, or a charger that has been approved by Invacare.
- Protect your charger from sources of heat such as heaters and direct sunlight. If the battery charger overheats, charging current will be reduced and the charging process delayed.

7.2.3 How to charge the batteries

1. Make sure you read and understand the battery charger's user manual, if supplied, as well as the safety notes on the front and rear panels of the charger.



WARNING!

Risk of explosion and destruction of batteries if the wrong battery charger is used

- Only ever use the battery charger supplied with your vehicle, or a charger that has been approved by Invacare.



WARNING!

Risk of electric shock and damage to the battery charger if it gets wet

- Protect the battery charger from water.
- Always charge in a dry environment.



WARNING!

Risk of short circuit and electric shock if the battery charger has been damaged

- Do not use the battery charger if it has been dropped or damaged.



WARNING!

Risk of electric shock and damage to the batteries

- NEVER attempt to recharge the batteries by attaching cables directly to the battery terminals.



WARNING!

Risk of fire and electric shock if a damaged extension cable is used

- Only ever use an extension cable if it is absolutely necessary. In case you must use one, make sure it is in good condition.



WARNING!

Risk of injury if using the wheelchair during charging

- DO NOT attempt to recharge the batteries and operate the wheelchair at the same time.
- DO NOT sit in the wheelchair while charging the batteries.

The charging socket is located on the left of the steering column.

1. Switch off the scooter.
2. Fold up the charging socket protective cap.
3. Connect the battery charger to the scooter.
4. Connect the battery charger to the power supply.

7.2.4 How to disconnect the batteries after charging

1. Disconnect the battery charger from the power supply.
2. Disconnect the battery charger from the scooter.
3. Close the charging socket protective cap.

7.2.5 Storage and Maintenance

Follow the instructions listed below to ensure safe use and longevity of the batteries:

- Always store the batteries fully charged.

- Do not leave the batteries in a low state of charge for an extended length of time. Charge a discharged battery as soon as possible.
- In case your mobility device is not used for a longer period of time (that is more than two weeks), the batteries must be charged at least once a month to maintain a full charge and always be charged before use.
- Avoid hot and cold extremes when storing. We recommend to store batteries at a temperature of 15 °C.
- Gel and AGM batteries are maintenance-free. Any performance issues should be handled by a properly trained mobility device technician.

7.2.6 Instructions on using the batteries



CAUTION!

Risk of damaging the batteries.

- Avoid ultra-deep discharges and never drain your batteries completely.

- Pay attention to the Battery Charge Indicator! Charge the batteries when the Battery Charge Indicator shows that battery charge is low. How fast the batteries discharge depends on many circumstances, such as ambient temperature, condition of the surface of the road, tire pressure, weight of the driver, way of driving and utilisation of lighting.
- Try to charge the batteries always before you reach the red LED range. The last 2 LED (one red and one orange) mean a remaining capacity of 20 — 30 %.

- Driving with blinking red LED means an extreme stress for the battery and should be avoided under normal circumstances.
- When only one red LED is blinking, the Battery Safe feature is enabled. From this time, speed and acceleration is reduced drastically. It will allow you to move the mobility device slowly out of a dangerous situation before the electronic finally cuts off. This is deep discharging and should be avoided.
- Be aware that for temperatures below 20 °C, the nominal battery capacity starts to decline. For example, at -10 °C the capacity is reduced to about 50 % of the nominal battery capacity.
- To avoid damaging the batteries, never allow them to be fully discharged. Do not drive on heavily discharged batteries if it is not absolutely necessary, as this will strain the batteries unduly and shorten their life expectancy.
- The earlier you recharge the batteries, the longer they live.
- The depth of discharge affects the cycle life. The harder a battery has to work, the shorter is its life expectancy. Examples:
 - One deep discharge stresses the same as 6 normal cycles (green /orange display off).
 - The battery life is about 300 cycles at 80% discharge (first 3 LED off), or about 3000 cycles at 10% discharge.
- Under normal operation, once a month the battery should be discharged until all green and orange LED are off. This should be done within one day. A 16 hour charge afterwards is necessary as reconditioning.

7.2.7 Transporting batteries

The batteries supplied with your mobility device are not hazardous goods. This classification is based on the German GGVS Hazardous Goods Road Transport Ordinances, and the IATA/DGR Hazardous Goods Rail Transport / Air Transport Ordinances. Batteries may be transported without restrictions, whether by road, rail or by air. Individual transport companies have, however, guidelines which can possibly restrict or forbid certain transport procedures. Please ask the transport company regarding each individual case.

7.2.8 General instructions on handling the batteries

- Never mix and match different battery manufactures or technologies, or use batteries that do not have similar date codes.
- Never mix gel with AGM batteries.
- The batteries reach their end of life when the drive range is significantly smaller than usual. Contact your provider or service technician for details.
- Always have your batteries installed by a properly trained mobility device technician or a person with adequate knowledge. They have the necessary training and tools to do the job safely and correctly.

7.2.9 Removing the batteries

1. Remove seat.
2. Remove battery and motor compartment cover.

3.

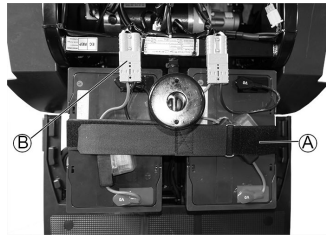

Open the battery retaining strap (A).

4. Unplug battery connecting plug (B).
5. Remove battery.
6. Repeat procedure for other battery.

 Replacing batteries takes place in reverse order.

7.2.10 How to handle damaged batteries correctly



CAUTION!

Corrosion and burns from acid leakage if batteries are damaged

– Remove clothes that have been soiled by acid immediately.

After contact with skin:

– Immediately wash affected area with lots of water.

After contact with eyes:

– Immediately rinse eyes under running water for several minutes; consult a physician.

- Always wear safety goggles and appropriate safety clothing when handling damaged batteries.

- Place damaged batteries in an acid-resistant receptacle immediately after removing them.
- Only ever transport damaged batteries in an appropriate acid-resistant receptacle.
- Wash all objects that have come into contact with acid with lots of water.

Disposing of dead or damaged batteries correctly

Dead or damaged batteries can be given back to your provider or directly to Invacare.

8 Transport

8.1 Transport - General information



WARNING!

Risk of severe or fatal injuries in the event of a traffic accident if this mobility device is used as a vehicle seat! It does not fulfill the requirements of ISO 7176-19.

- Under no circumstances should this mobility device be used as a vehicle seat or to transport the user in a vehicle.



WARNING!

Risk of death or serious injury to the mobility device user and potentially any other nearby occupant of the vehicle, if a mobility device is secured using a 4-point tie-down system available from a third party supplier and the unladen weight of the mobility device exceeds the maximum weight for which the tie-down system is certified.

- Make sure the weight of the mobility device does not exceed the weight for which the tie-down system is certified. Consult the tie-down manufacturer's documentation.
- If you are unsure how much your mobility device weighs, then you must have it weighed using calibrated scales.

8.2 Transferring the mobility device to a vehicle



WARNING!

The mobility device is at risk of tipping over if it is transferred to a vehicle while the user is still seated in the mobility device

- Transfer the mobility device without the user whenever possible.
- If the mobility device with the user has to be transferred to a vehicle using a ramp, ensure that the ramp does not exceed the rated slope (refer to 12 Technical data, page 59).
- If the mobility device has to be transferred to a vehicle using a ramp that does exceed the rated slope (refer to 12 Technical data, page 59), a winch must then be used. An attendant can then safely monitor and assist the transfer process.
- Alternatively, a platform lift may be used.
- Ensure that the total weight of the mobility device including the user does not exceed the maximum permitted total weight for the ramp or platform lift.
- The mobility device should always be transferred to a vehicle with the backrest in an upright position, the seat lifter lowered and the seat tilt in the upright position (refer to Driving up and down gradients).



WARNING!

Risk of injury and damage to the mobility device

If the mobility device is to be transferred to a vehicle via a lift, when the remote is turned on, there is a risk that the device may act erratically and fall off the lift.

- Before transferring the mobility device via a lift, turn off the product and disconnect either the bus cable from the remote or the batteries from the system.

1. Drive or push your mobility device into the transport vehicle using a suitable ramp.

8.3 Transporting the mobility device without occupant



CAUTION!

Risk of injury

- If you are unable to fasten your mobility device securely in a transport vehicle, Invacare recommends that you do not transport it.

Your mobility device may be transported without restrictions, whether by road, rail or by air. Individual transport companies have, however, guidelines which can possibly restrict or forbid certain transport procedures. Please ask the transport company regarding each individual case.

- Before transporting your mobility device, make sure the motors are engaged and that the remote is switched off. Invacare strongly recommends that you additionally disconnect or remove the batteries. Refer to Removing the batteries.

- Invacare strongly recommends securing the mobility device to the floor of the transporting vehicle.

9 Maintenance

9.1 Maintenance introduction

The term “Maintenance“ means any task performed to ensure that a medical device is in good working order and ready for use as intended. Maintenance encompasses different areas, such as everyday care and cleaning, inspection checks, repair tasks and refurbishment.



Have your vehicle checked once a year by an authorized Invacare provider in order to maintain its driving safety and roadworthiness.

9.2 Cleaning the mobility device

When cleaning the mobility device, pay attention to the following points:

- Only use a damp cloth and gentle detergent.
- Do not use any abrasive or scouring agents.
- Do not subject the electronic components to any direct contact with water.
- Do not use any high-pressure cleaning devices.

Disinfection

Spray or wipe disinfection using a tested and recognised product is permitted. A list of the current permitted disinfectants is available from the Robert Koch Institute at <http://www.rki.de>.

9.3 Inspection checks

The following tables list inspection checks that should be performed by the user within the indicated intervals. If the

mobility device fails to pass one of the inspection checks, refer to the chapter indicated or contact your authorized Invacare provider. A more comprehensive list of inspection checks and instructions for maintenance work can be found in the service manual for this device, which can be obtained from Invacare. That manual, however, is intended to be used by trained and authorized service technicians, and describes tasks which are not intended to be performed by the user.

Before each use of the mobility device

Item	Inspection check	If inspection is not passed
Signal horn	Check for correct function.	Contact your provider.
Batteries	Make sure the batteries are charged.	Charge the batteries (refer to 7.2.3 How to charge the batteries, page 45).
Lighting system	Check that all lights, such as turn indicators, front and rear lights, are functioning correctly.	Contact your provider.

Weekly

Item	Inspection check	If inspection is not passed
Arm-rests/side parts	Check that armrests are firmly attached in their holders and do not wobble.	Tighten the screw or clamping lever that holds the armrest (refer to 4.3 Adjusting the armrest width, page 24). Contact your provider.
Tires (pneumatic)	Check that the tires are undamaged and inflated to the correct pressure.	Inflate the tire to the correct pressure (see chapter 12 Technical data, page 59). If you have a damaged tire, contact your provider.

Monthly

Item	Inspection check	If inspection is not passed
Seat and backrest padding	Check for perfect condition.	Contact your provider.
All upholstered parts	Check for damage and wear.	Contact your provider.

Item	Inspection check	If inspection is not passed
Drive wheels	Check that the drive wheels rotate without wobbling. It is easiest to have someone stand behind the mobility device and observe the drive wheels as you drive away from them to do this.	Contact your provider.
Electronics and connectors	Check all cables for damage and all connecting plugs for snug fit.	Contact your provider.

9.4 Wheels and tires**Dealing with wheel damages**

In case of having a damaged wheel, contact your provider. Because of safety reasons do not have the wheel repaired by yourself or by not authorized persons.

Dealing with pneumatic tires**Risk of damage to tire and rim**

Never drive with too low tire pressure, this could result in damage to tire.
If tire pressure is exceeded rim could be damaged.
– Inflate tires to recommended pressure.



Use tire gauge to check pressure.

Check weekly that the tires are inflated to the correct pressure, see chapter Inspection checks.

For recommended tire pressure see inscription on tire/rim or contact Invacare. Compare table below for conversion.

psi	bar
22	1.5
23	1.6
25	1.7
26	1.8
28	1.9
29	2.0
30	2.1
32	2.2
33	2.3
35	2.4
36	2.5
38	2.6
39	2.7
41	2.8
44	3.0

9.5 Long-term storage

In case your mobility device is not used for a longer period of time, you need to prepare it for storage to ensure a longer life for your mobility device and batteries.

Storing mobility device and batteries

- We recommend to store the mobility device at a temperature of 15° C, avoid hot and cold extremes when storing to ensure a long service life of the product and batteries.
- The components are tested and approved for greater temperature ranges as detailed below:
 - Allowable temperature range to store the mobility device is -40° up to 65° C.
 - Allowable temperature range to store batteries is -25° up to 65° C.
- Even not being used, batteries discharge themselves. Best practice is to disconnect the battery supply from the power module if storing the mobility device longer than two weeks. Depending on the mobility device model, you can either remove the battery packs or disconnect the batteries from the power module. Refer to the corresponding chapter about disconnecting the batteries. If in doubt which cable to disconnect, contact your provider.
- Batteries should always be fully charged before storing.
- If storing the mobility device longer than four weeks, check the batteries once a month and recharge as needed (before gauge reads half full) to avoid damage.
- Store in a dry, well-ventilated environment protected from outer influences.
- Slightly overinflate pneumatic tires.

- Position the mobility device on flooring that is not discolored by contact with tire rubber.

Preparing mobility device for use

- Re-connect the battery supply to the power module.
- The batteries must be charged before use.
- Have the mobility device checked by an authorized Invacare provider.

10 After Use

10.1 Reconditioning

The product is suitable for reuse. To recondition the product for a new user, carry out the following actions:

- Cleaning and disinfection. Refer to 9 Maintenance, page 51.
- Inspection according to service plan. Consult service instructions, available from Invacare.
- Adaptation to the user. Refer to 4 Setup, page 23.

10.2 Disposal

- The equipment wrapping is potentially recyclable.
- The metal parts are used for scrap metal recycling.
- The plastic parts are used for plastic recycling.
- Electric components and printed circuit boards are disposed of as electronic scrap.
- Exhausted or damaged batteries can be returned to your medical equipment supplier or Invacare.
- Disposal must be carried out in accordance with the respective national legal provisions.
- Ask your city or district council for details of the local waste management companies.

11 Troubleshooting

11.1 Diagnosis and fault repair

The electronic system offers diagnostic information to support the technician during the recognition and rectification of faults on the scooter.

The electronic system reacts differently depending on the seriousness of the fault and its effect on user safety. It can, for example:

- Display the error code as a warning and allow both driving and normal operation to continue.
- Display the error code, stop the scooter and prevent further travel until the electronic system has been switched off and switched on again.
- Display the error code, stop the scooter and not permit further travel until the fault has been rectified.

You can find detailed descriptions of individual error codes, including possible causes and fault repair, in 11.1.2 Error codes and diagnostic codes, page 57.

11.1.1 Error diagnosis

If the scooter shows a failure, use the following guide to locate the fault.

 Before making any diagnosis, ensure that the scooter has been switched on at the keyswitch.

If the status display/LCD display is OFF:

- Check whether the keyswitch is SWITCHED ON.
- Check whether all cables are correctly connected.

LED console

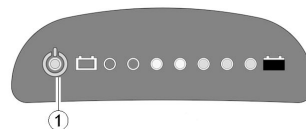

If there is a fault, the status display (1) flashes several times, pauses, then flashes again. The type of fault is displayed by the number of flashes which are also known as the "flash code". Count the number of flashes and proceed to 11.1.2 Error codes and diagnostic codes, page 57.

LCD console

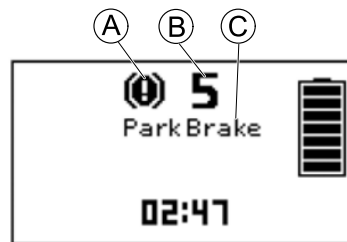

If there is a fault, the fault indication symbol (A), the number (B) and the name of the fault (C) are shown in the LCD display. Refer to 11.1.2 Error codes and diagnostic codes, page 57.

11.1.2 Error codes and diagnostic codes

Flash code	Fault	Consequence for the scooter	Comments
1	Batteries must be charged	Continues to drive	<ul style="list-style-type: none"> The batteries are discharged. Charge the batteries as soon as possible.
2	Battery voltage too low	Stops driving	<ul style="list-style-type: none"> The batteries are depleted. Charge batteries. If you switch the scooter off for a few minutes, the batteries can often recuperate to such a stage that a short journey is still possible. You should only do this in an emergency, however, because this causes the batteries to become excessively discharged.
3	Battery voltage too high	Stops driving	<ul style="list-style-type: none"> The battery voltage is too high. If the battery charger is connected, disconnect it from the scooter. The electronic system charges the batteries when running downhill and when braking. This fault is caused when the battery voltage becomes too high during this process. Switch the scooter off and on again.
4	Power time exceeded	Stops driving	<ul style="list-style-type: none"> The maximum current was exceeded over too long a period, probably because the motor was overloaded or has been working against an immovable resistance. Switch the scooter off, wait a few minutes and then switch on again. The electronic system has determined a motor short-circuit. Check the wiring harness for short-circuit and check the motor. Contact your Invacare provider.

Flash code	Fault	Consequence for the scooter	Comments
5	Brake failure	Stops driving	<ul style="list-style-type: none"> • Ensure that the disengaging lever is in the engaged position. • There is a defect in the braking coil or in the cabling. Check the magnetic brake and cabling for open or short-circuited circuitry. Contact your Invacare provider.
6	No neutral position when switching scooter on.	Stops driving	<ul style="list-style-type: none"> • Drive lever is not in neutral when the keyswitch was turned. Put the drive lever in neutral, turn the power off and then turn on again. • It may be necessary to replace the drive lever. Contact your Invacare provider.
7	Fault in speed potentiometer	Stops driving	<ul style="list-style-type: none"> • The drive lever controls could be faulty or incorrectly connected. Check the cabling for open or short-circuited circuitry. • Potentiometer is not correctly adjusted and must be replaced. Contact your Invacare provider.
8	Motor voltage error	Stops driving	<ul style="list-style-type: none"> • The motor or its cabling is defective. Check the cabling for open or short-circuited circuitry.
9	Miscellaneous internal fault	Stops driving	<ul style="list-style-type: none"> • Contact your Invacare provider.
10	Push/freewheel mode error	Stops moving	<ul style="list-style-type: none"> • The scooter has exceeded the permissible maximum speed during pushing or freewheeling. Switch the electronics system off and on again.

12 Technical data

12.1 Technical specifications

The technical information provided hereafter applies to a standard configuration or represents maximum achievable values. These can change if accessories are added. The precise changes to these values are detailed in the sections for the respective accessories.



Note that in some cases the measured values may vary up to ± 10 mm.

Permissible operating and storage conditions	
Temperature range for operation according to ISO 7176-9:	<ul style="list-style-type: none"> -25° ... +50 °C
Recommended storage temperature:	<ul style="list-style-type: none"> 15 °C
Temperature range for storage according to ISO 7176-9:	<ul style="list-style-type: none"> -25° ... +65 °C with batteries -40° ... +65 °C without batteries
Charging device	
Output current	<ul style="list-style-type: none"> 8 A \pm 8 %
Output voltage	<ul style="list-style-type: none"> 24 V nominal (12 cells)

Electrical system		
	Pegasus^{METRO}	Pegasus^{PRO}
Motor	<ul style="list-style-type: none"> 6 km/h: S1: 240 W, Maxpeak 500 W 10 km/h: S1: 240 W, Maxpeak 600 W 12 km/h: S1: 550 W, Maxpeak 1500 W 	<ul style="list-style-type: none"> 6 km/h: S1 240 W, Maxpeak 500 W (only 4-wheel) 10 km/h: S1 550 W, Maxpeak 1300 W 12 km/h: S1 550 W, Maxpeak 1500 W 12.8 km/h: S1 550 W, Maxpeak 1600 W 15 km/h: S1 550 W, Maxpeak 1600 W
Batteries	<ul style="list-style-type: none"> 2 x 12 V/50 Ah (C20) leakproof/AGM 	<ul style="list-style-type: none"> 2 x 12 V/75 Ah (C20) leakproof/AGM
Main fuse	<ul style="list-style-type: none"> 70 A 	<ul style="list-style-type: none"> 100 A
Degree of protection	IPX4 ¹	

Tires		
	Pegasus^{METRO}	Pegasus^{PRO}
Tire type	<ul style="list-style-type: none"> 4.10 / 3.50 - 5 pneumatic 11.5 x 3.50 - 5 pneumatic 11 x 3.50 - 6 pneumatic <p>The recommended maximum tire pressure in bar or kpa is marked on the side wall of the tire or the rim. If more than one value is listed, the lower one in the corresponding units applies. (Tolerance = -0.3 bar, 1 bar = 100 kpa)</p>	<ul style="list-style-type: none"> 4.10 / 3.50 - 6 pneumatic 12 x 4.00 - 5 pneumatic 12 x 4.00 - 6 pneumatic <p>The recommended maximum tire pressure in bar or kpa is marked on the side wall of the tire or the rim. If more than one value is listed, the lower one in the corresponding unit applies. (Tolerance = -0.3 bar, 1 bar = 100 kpa)</p>
Tire type	<ul style="list-style-type: none"> 11" puncture-proof 	<ul style="list-style-type: none"> 12" puncture-proof

Driving characteristics		
	Pegasus^{METRO}	Pegasus^{PRO}
Speed	<ul style="list-style-type: none"> • 6 km/h • 10 km/h • 12 km/h 	<ul style="list-style-type: none"> • 6 km/h (only 4-wheel) • 10 km/h • 12 km/h • 12.8 km/h • 15 km/h
Min. braking distance	<ul style="list-style-type: none"> • 1000 mm (6 km/h) • 2100 mm (10 km/h) • 2900 mm (12 km/h) 	<ul style="list-style-type: none"> • 1000 mm (6 km/h, only 4-wheel) • 2100 mm (10 km/h) • 2900 mm (12 km/h) • 4500 mm (15 km/h)
Rated slope	<ul style="list-style-type: none"> • 3-wheel: 6° (10.5 %)² • 4-wheel: 6° (10.5 %)² 	<ul style="list-style-type: none"> • 3-wheel: 10° (17.6 %)³ • 4-wheel: 10° (17.6 %)³
Max. climbable obstacle height	<ul style="list-style-type: none"> • 80 mm 	<ul style="list-style-type: none"> • 100 mm
Turning radius	<ul style="list-style-type: none"> • 3-wheel: 2250 mm • 4-wheel: 2600 mm 	<ul style="list-style-type: none"> • 3-wheel: 2500 mm • 4-wheel: 2750 mm
Turning width	<ul style="list-style-type: none"> • 3-wheel: 1650 mm • 4-wheel: 1720 	<ul style="list-style-type: none"> • 3-wheel: 1690 mm • 4-wheel: 1800 mm
Drive range in accordance with ISO 7176-4 ⁴	<ul style="list-style-type: none"> • 54 – 43 km 	<ul style="list-style-type: none"> • 52 km

Dimensions according to ISO 7176-15		
	Pegasus^{METRO}	Pegasus^{PRO}
Total length	<ul style="list-style-type: none"> • 3-wheel: 1240 mm • 4-wheel: 1270 mm 	<ul style="list-style-type: none"> • 3-wheel: 1300 mm • 4-wheel: 1320 mm
Drive unit width	<ul style="list-style-type: none"> • 660 mm 	<ul style="list-style-type: none"> • 650 mm
Total width (armrest adjustment range)	<ul style="list-style-type: none"> • 660 ... 685 mm 	<ul style="list-style-type: none"> • 3-wheel: 685 ... 710 mm • 4-wheel: 630 ... 725 mm
Total height	<ul style="list-style-type: none"> • 1255 mm 	<ul style="list-style-type: none"> • 3-wheel: 1290 mm • 4-wheel: 1255 mm
Stowage length	<ul style="list-style-type: none"> • 1325 mm ... 1475 mm 	
Stowage width	<ul style="list-style-type: none"> • 660 mm 	
Stowage height	<ul style="list-style-type: none"> • 705 mm 	
Ground clearance	<ul style="list-style-type: none"> • 78 mm 	<ul style="list-style-type: none"> • 100 mm
Ground clearance "Anti-tipper to floor"	<ul style="list-style-type: none"> • 62 mm 	<ul style="list-style-type: none"> • 90 mm
Seat width	Comfort, Deluxe and Premium seat: <ul style="list-style-type: none"> • 510 mm 	
Seat depth	<ul style="list-style-type: none"> • Comfort and Deluxe seat: 470 mm • Premium seat: 460 mm 	
Seat height ⁵ (seatbase to floor pan distance)	Comfort, Deluxe and Premium seat: <ul style="list-style-type: none"> • 440/465/490/515 mm 	Comfort, Deluxe and Premium seat: <ul style="list-style-type: none"> • 3-wheel: 440/465 mm • 4-wheel: 440/465/490/515 mm

Dimensions according to ISO 7176-15		
	Pegasus^{METRO}	Pegasus^{PRO}
Seat surface height at front edge	<ul style="list-style-type: none"> • 550 mm ... 625 mm 	
Seat angle	<ul style="list-style-type: none"> • 5° ... 8° 	
Backrest height ⁶	<ul style="list-style-type: none"> • Comfort seat: 500 mm • Deluxe seat: 490 mm • Premium seat: 630 mm 	
Backrest angle	<ul style="list-style-type: none"> • 90° ... 130° 	
Armrest height	<ul style="list-style-type: none"> • 200 mm ... 245 mm 	
Armrest depth	<ul style="list-style-type: none"> • 360 mm ... 520 mm 	

Weight		
	Pegasus^{METRO}	Pegasus^{PRO}
Curb weight	<ul style="list-style-type: none"> • 3-wheel: 103 kg • 4-wheel: 110 kg 	<ul style="list-style-type: none"> • 3-wheel: 126 kg • 4-wheel: 136 kg

Component weights		
	Pegasus^{METRO}	Pegasus^{PRO}
Chassis	<ul style="list-style-type: none"> • 3-wheel: approx. 52 kg • 4-wheel: approx. 57 kg 	<ul style="list-style-type: none"> • 4-wheel: approx. 62 kg
Seat unit	<ul style="list-style-type: none"> • approx. 21 kg 	<ul style="list-style-type: none"> • 3-wheel: 26 kg • 4-wheel: 21 kg
Batteries	<ul style="list-style-type: none"> • approx. 26 kg per battery 	

Payload		
	Pegasus^{METRO}	Pegasus^{PRO}
Max. payload	<ul style="list-style-type: none"> • 136 kg 	<ul style="list-style-type: none"> • 3-wheel: 127 kg • 4-wheel: 160 kg

Axle loads		
	Pegasus^{METRO}	Pegasus^{PRO}
Max. front axle load	<ul style="list-style-type: none"> • 3-wheel: 86 kg • 4-wheel: 87 kg 	<ul style="list-style-type: none"> • 3-wheel: 110 kg • 4-wheel: 90 kg
Max. rear axle load	<ul style="list-style-type: none"> • 3-wheel: 206 kg • 4-wheel: 209 kg 	<ul style="list-style-type: none"> • 3-wheel: 258 kg • 4-wheel: 212 kg

- 1 IPX4 classification means that the electrical system is protected against spray water.
- 2 Static stability according to ISO 7176-1 = 9° (15.8 %)
Dynamic stability according to ISO 7176-2 = 6° (10.5 %)
- 3 Static stability according to ISO 7176-1 = 15° (26.8 %)
Dynamic stability according to ISO 7176-2 = 10° (17.6 %)
- 4 Note: The drive range of a mobility device is strongly influenced by external factors, such as the speed setting of the wheelchair, the charging state of the batteries, surrounding temperature, local topography, road surface characteristics, tire pressure, weight of user, drive style and use of batteries for lighting, servos etc.

The specified values are theoretical maximum achievable values measured according to ISO 7176-4.
- 5 Measured without seat cushion
- 6 Measured without headrest

13 Service

13.1 Inspections performed

It is confirmed by stamp and signature that all jobs listed in the inspection schedule of the service and repair instructions have been properly performed. The list of the inspection jobs to be performed can be found in the service manual which is available through Invacare.

Delivery Inspection	1st Annual Inspection
Stamp of authorized provider / Date / Signature	Stamp of authorized provider / Date / Signature
2nd Annual Inspection	3rd Annual Inspection

Stamp of authorized provider / Date / Signature	Stamp of authorized provider / Date / Signature
4th Annual Inspection	5th Annual Inspection
Stamp of authorized provider / Date / Signature	Stamp of authorized provider / Date / Signature

Invacare representatives/distributors

Australia:

Invacare Australia PTY. Ltd.
1 Lenton Place, North Rocks NSW
2151
Australia
Phone: 1800 460 460
Fax: 1800 814 367
orders@invacare.com.au
www.invacare.com.au

United Kingdom:

Invacare Limited
Pencoed Technology Park, Pencoed
Bridgend CF35 5AQ
Tel: (44) (0) 1656 776 222
Fax: (44) (0) 1656 776 220
uk@invacare.com
www.invacare.co.uk

EC	REP
----	-----

Canada:

Invacare Canada LP
570 Matheson Blvd E. Unit 8
Mississauga Ontario
L4Z 4G4, Canada
Phone: (905) 890 8300
Fax: (905) 501 4336

Eastern Europe, Middle East & CIS:

Invacare EU Export
Kleiststraße 49
D-32457 Porta Westfalica / Germany
Tel: (49) (0)57 31 754 540
Fax: (49) (0)57 31 754 541
webinfo-eu-export@invacare.com
www.invacare-eu-export.com

European representative:

EMERGO EUROPE
Molenstraat 15
2513 BH, The Hague
The Netherlands

European representative address from July 1st, 2017:

EMERGO EUROPE
Prinsessegracht 20
2514 AP, The Hague
The Netherlands

Ireland:

Invacare Ireland Ltd,
Unit 5 Seatown Business Campus
Seatown Road, Swords, County Dublin
Tel : (353) 1 810 7084
Fax: (353) 1 810 7085
ireland@invacare.com
www.invacare.ie

New Zealand:

Invacare New Zealand Ltd
4 Westfield Place, Mt Wellington 1060
New Zealand
Phone: 0800 468 222
Fax: 0800 807 788
sales@invacare.co.nz
www.invacare.co.nz



Manufacturer:

CHIEN TI ENTERPRISE CO. LTD.
No. 13, Lane 227, Fu Ying Road
Hsin Chuang, Taipei, Taiwan
R.O.C.

1638629-A 2017-02-16



Making Life's Experiences Possible®



Yes, you can.®